

## **CARDIOVASCULAR & THORACIC INSTRUMENTS**

# VEIN STRIPPERS & ENDARTERECTOMY INSTRUMENTS

Venenstripper und Endarteriektomie-Instrumente | Strippers de venas e instrumentos de endarterectomia  
 Vein Strippers & Instruments d'endartériectomie | Estrattori di vene e strumenti per endoarteriectomia

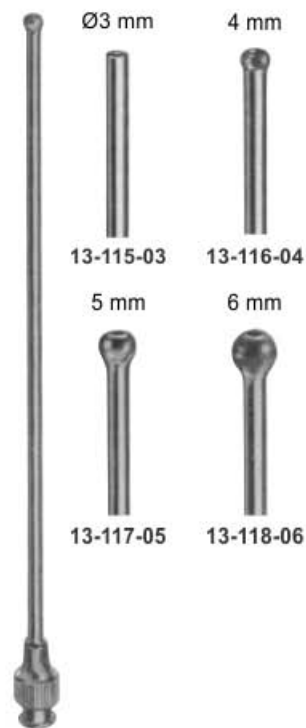
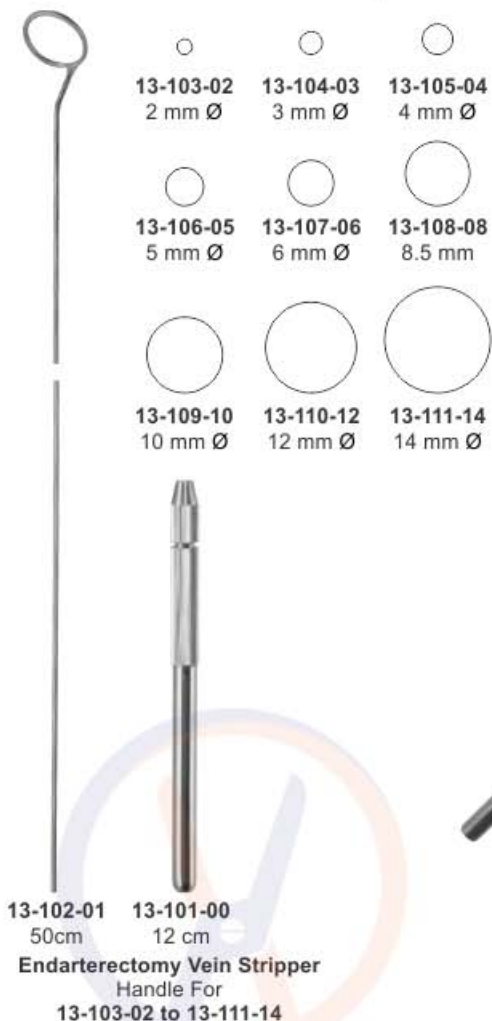

**SCHMID**  
 13-115-03 - 13-118-06  
 Vessel irrigating cannulae,  
 malleable, silver plated  
 15cm  
 LUER LOCK



**Blake Gall Stone Forceps**  
 13-119-20 20 cm  
 Straight

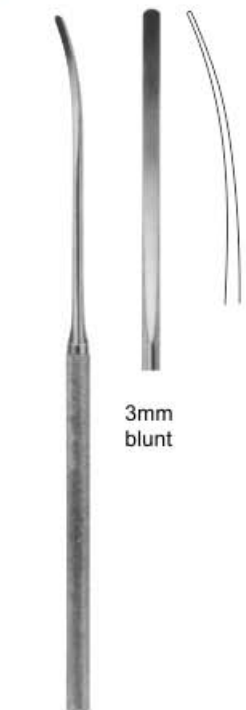

13-120-18 18.5cm  
 13-121-21 21.5cm  
 Vascular spatula

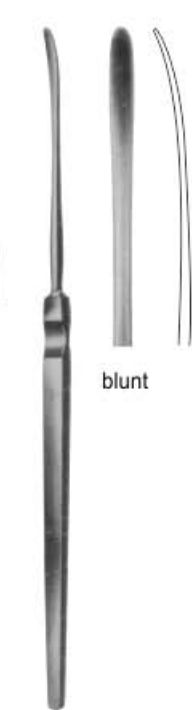

**HALLE**  
 13-122-18 18cm  
 Vascular spatula

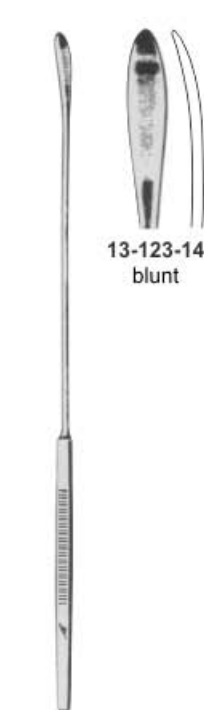

**SCHMID**  
 13-123-14 14cm  
 13-124-23 23.5cm  
 Vascular spatula



maleable



**BABCOCK**  
 13-125-40 40cm  
 13-126-50 50cm  
 13-127-65 65cm  
 13-128-80 80cm

Sounds for varicose veins



**Nabatoff Varicose Vein Stripper**  
**13-129-00**  
135mmx100mmx25mm  
complete

**13-130-01**  
**Nabatoff**  
Metal Case

**13-131-02**  
**Nabatoff**  
Handle



**13-133-04**  
**Nabatoff**  
Probe tip in plastic



**Nabatoff**  
Metal Probe  
**13-134-05**  
3mm



**Nabatoff**  
Metal Olive  
**13-135-06**



**Nabatoff**  
Metal Olive  
**13-136-07**  
9mm

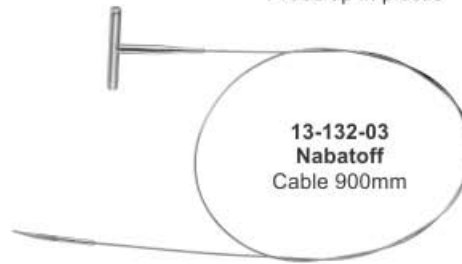

**13-132-03**  
**Nabatoff**  
Cable 900mm



**Nabatoff**  
Metal Olive  
**13-137-08**  
12mm



**Nabatoff**  
Metal Olive  
**13-138-09**  
15mm



**13-144-01**  
6mm

**13-145-02**  
8mm

**13-146-03**  
10mm

**13-147-04**  
12mm



**13-148-05**



**13-149-06**



**Martin**  
**13-139-00**  
Tunneling Set complete set with three  
shafts, two handles and 12 tips in storage  
case.

- 13-139-00** Tunneling set complete
- 13-140-07** Universal handle (2x)
- 13-141-08** Tunneling shaft, curved, 225mm
- 13-142-09** Tunneling shaft, straight, 225mm
- 13-143-10** Tunneling shaft, curved, 540mm
- 13-144-01** Bullet tip 6mm (2 x)
- 13-145-02** Bullet tip 8mm (2 x)
- 13-146-03** Bullet tip 10mm (2 x)
- 13-147-04** Bullet tip 12mm (2 x)
- 13-148-05** Vein tip
- 13-149-06** Luer Adaptor
- Plate for tips only
- Sterilizing cases 550 x 115 x 35mm



**13-140-07** **13-141-08** **13-142-09** **13-143-10**  
22.5cm 22.5cm 54cm





X Length  
Ø Vessel  
V Vein  
A Artery

## APPROXIMATORS BIEMER CLIPS



X=8mm  
13-150-08 V  
13-151-08 A  
Ø=0,4 mm - 1 mm



X=8mm  
13-152-08 V  
13-153-08 A  
Ø=0,4 mm - 1 mm



X=8mm  
13-154-08 V  
13-155-08 A  
Ø=0,4 mm - 1 mm



X=8mm  
13-156-08 V  
13-157-08 A  
Ø=0,4 mm - 1 mm



X=11mm  
13-158-11 V  
13-159-11 A  
Ø=0,6 mm - 1,5 mm



X=11mm  
13-160-11 V  
13-161-11 A  
Ø=0,6 mm - 1,5 mm



X=11mm  
13-162-11 V  
13-163-11 A  
Ø=0,6 mm - 1,5 mm



X=11mm  
13-164-11 V  
13-165-11 A  
Ø=0,6 mm - 1,5 mm



X=14mm  
13-166-14 V  
13-167-14 A  
Ø=1 mm - 2 mm



X=14mm  
13-168-14 V  
13-169-14 A  
Ø=1 mm - 2 mm



X=14mm  
13-170-14 V  
13-171-14 A  
Ø=1 mm - 2 mm



X=14mm  
13-172-14 V  
13-173-14 A  
Ø=1 mm - 2 mm



X=17mm  
13-174-17 V  
13-175-17 A  
Ø=1 mm - 2,25 mm



X=17mm  
13-176-17 V  
13-177-17 A  
Ø=1 mm - 2,25 mm



X=17mm  
13-178-17 V  
13-179-17 A  
Ø=1 mm - 2,25 mm



X=17mm  
13-180-17 V  
13-181-17 A  
Ø=1 mm - 2,25 mm



X=25mm  
13-182-25 V  
13-183-25 A  
Ø=1,5 mm - 3,5 mm



X=25mm  
13-184-25 V  
13-185-25 A  
Ø=1,5 mm - 3,5 mm



X=25mm  
13-186-25 V  
13-187-25 A  
Ø=1,5 mm - 3,5 mm



X=25mm  
13-188-25 V  
13-189-25 A  
Ø=1,5 mm - 3,5 mm



X=36mm  
13-190-36 V  
13-191-36 A  
Ø=1,5 mm - 3,5 mm



X=36mm  
13-192-36 V  
13-193-36 A  
Ø=1,5 mm - 3,5 mm



X=36mm  
13-194-36 V  
13-195-36 A  
Ø=1,5 mm - 3,5 mm



X=36mm  
13-196-36 V  
13-197-36 A  
Ø=1,5 mm - 3,5 mm

## APPROXIMATORS, BIEMER CLIPS, CLIP APPLYING FORCEPS

Approximatoren, Biemer-Clips, Clip-Anlegezangen  
 Approximateurs, pinces Biemer, pinces d'application de pinces

Aproximadores, Clips Biemer, Pinzas Aplicadoras de Clips  
 Approssimatori, clip Biemer, pinze per l'applicazione di clip

### Biemer Vessel Approximator with adjustable clip distance

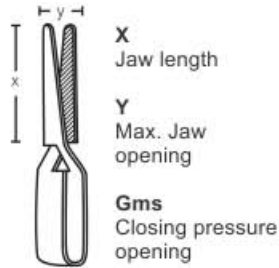

**Biemer Vessel Clip**



**13-198-06**  
x=6mm  
y=4mm  
gms=30-40



**13-199-09**  
x=9mm  
y=5mm  
gms=30-40



**13-200-06**  
x=9mm  
y=5mm  
gms=20-25

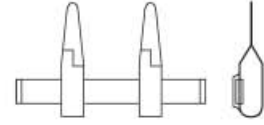

**13-201-04**  
x=4.5mm  
y=3.0mm  
gms=30-40

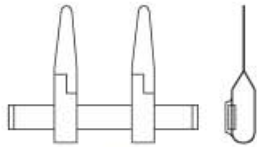

**13-202-09**  
x=9mm  
y=5mm  
gms=30-40

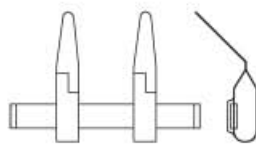

**13-203-09**  
x=9mm  
y=5mm  
gms=30-40

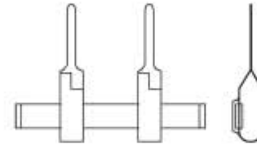

**13-204-09**  
x=9mm  
y=5mm  
gms=20-25

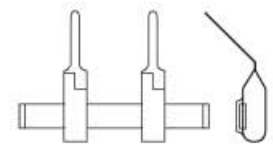

**13-205-09**  
x=9mm  
y=5mm  
gms=30-40

For temporary occlusion, (identified by yellow coloured spring ends) for vessels of 0.5mm-2.0mm. Blade gripping surface with oblique serrations for save but careful gripping of vessels. No risk due to rigidly fixed pressure measure.



**Biemer 13-206-14**  
14.5 cm  
applying forceps  
with lock



**Biemer 13-207-14**  
14.5 cm  
applying forceps  
without lock



**Clip Applying Forceps 13-208-01** 14 cm with lock  
**13-209-02** 14 cm with out lock



**Clip Applying Forceps 13-210-14** 14cm  
for approximators  
and double-clips

## BIEMER CLIPS, CLIP APPLYING FORCEPS

Biemer-Clips, Clip-Anlegezange

Clips de Biemer, pinzas de aplicación de clips

Clips Biemer, pinces d'application de clips

Clip Biemer, pinza per l'applicazione di clip

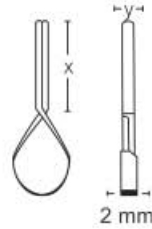

X=Jaw length  
y=max. Opening  
gms=Pressure

for temporary closure



**Biemer Clips  
applying forceps**  
15 cm  
with ratchet  
13-211-15

**Biemer Clips  
applying forceps**  
18 cm  
with ratchet,  
bayonet shaped  
13-212-18

For clips 13-213-31 to 49-166-21

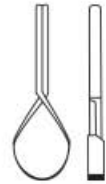

**13-213-31**  
x=10.0 mm  
y=1.5 mm  
gms=70

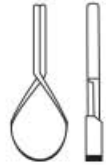

**13-214-21**  
x=8.0 mm  
y=1.0 mm  
gms=70



**13-215-11**  
x=6.0 mm  
y=0.8 mm  
gms=70

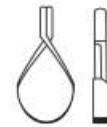

**13-216-01**  
x=4.0 mm  
y=0.75 mm  
gms=70

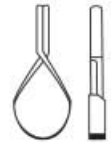

**13-217-12**  
x=6.0 mm  
y=1.0 mm  
gms=70



**13-218-11**  
x=6.0 mm  
y=1.0 mm  
gms=70



**13-219-12**  
x=6.0 mm  
y=1.0 mm  
gms=70

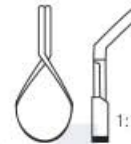

**13-220-13**  
x=6.0 mm  
y=1.0 mm  
gms=70

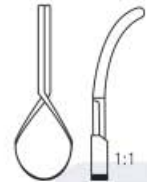

**13-221-31**  
x=10.0 mm  
y=1.0 mm  
gms=70



**13-222-31**  
x=10.0 mm  
y=2.0 mm  
gms=150

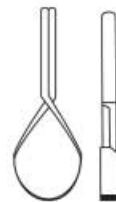

**13-223-21**  
x=8.0 mm  
y=2.0 mm  
gms=150



**13-224-11**  
x=6.0 mm  
y=1.0 mm  
gms=150

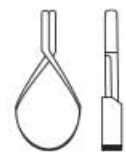

**13-225-01**  
x=4.0 mm  
y=0.75 mm  
gms=150



**13-226-11**  
x=6.0 mm  
y=1.0 mm  
gms=150



**13-227-12**  
x=6.0 mm  
y=1.0 mm  
gms=150

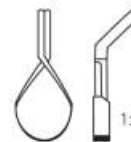

**13-228-13**  
x=6.0 mm  
y=1.0 mm  
gms=150

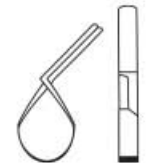

**13-229-21**  
x=8.0 mm  
y=2.0 mm  
gms=150



**Johns Hopkins Bulldog Clamps**  
serrated jaws

**13-230-38**  
38 mm  
straight

**13-231-50**  
50 mm  
straight

**13-232-55**  
55 mm  
straight

**13-233-65**  
65 mm  
straight

**13-234-70**  
70 mm  
straight

**13-235-75**  
75 mm  
straight

**13-236-90**  
90 mm  
straight

**13-237-38**  
38 mm  
slightly curved

**13-238-50**  
50 mm  
slightly curved

**13-239-55**  
55 mm  
slightly curved

**13-240-65**  
65 mm  
slightly curved

**13-241-70**  
70 mm  
slightly curved

**13-242-75**  
75 mm  
slightly curved

**13-243-90**  
90 mm  
slightly curved



**Bulldog Clamp Applying Forceps**  
**13-244-23** 23 cm  
angled tips



**Diethrich Micro-Corony Bulldog Clamps**  
5 cm  
straight

**13-245-08**  
8 mm

**13-246-12**  
12 mm

**13-247-16**  
16 mm

**13-248-20**  
20 mm



**Diethrich Micro-Corony Bulldog Clamps**  
5 cm angled jaws

**13-249-08**  
8 mm

**13-250-12**  
12 mm

**13-251-13**  
13 mm

**13-252-16**  
16 mm

**13-253-18**  
18 mm

**13-254-20**  
20 mm



## BULLDOG CLAMPS

Bulldogklemmen	Clamps Bulldog
Clamps Bulldog	Pinze Bulldog



**DIEFFENBACH**  
13-255-35 35mm  
13-256-50 50mm



**DIEFFENBACH**  
13-257-35 35mm  
13-258-50 50mm



**DIEFFENBACH**  
13-259-57  
57mm



**DIEFFENBACH**  
13-260-57  
57mm



**De BAKEY-HESS**  
13-261-20  
Length of jaws:  
20mm



**De BAKEY-HESS**  
13-262-30  
Length of jaws:  
30mm



**De Bakey Bulldog Clamp** straight cross action



**13-263-20**  
75 mm  
jaw length 2 cm



**13-264-30**  
85 mm  
jaw length 3 cm



**De Bakey Bulldog Clamp** curved cross action



**13-267-20**  
70 mm  
jaw length 2 cm



**13-268-30**  
80 mm  
jaw length 3 cm



**13-265-45**  
105 mm  
jaw length 4.5 cm



**13-266-65**  
120 mm  
jaw length 6.5 cm



**13-269-45**  
100 mm  
jaw length 4.5 cm



**13-270-65**  
115 mm  
jaw length 6.5 cm



## BULLDOG CLAMPS

Bulldogklemmen	Clamps Bulldog
Clamps Bulldog	Pinze Bulldog

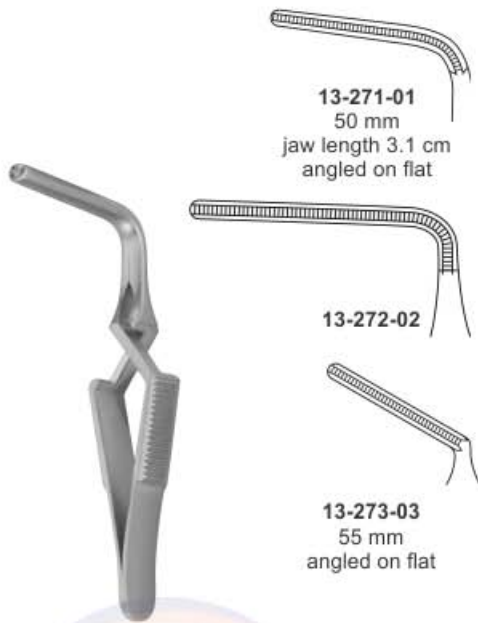

**Santulli Atraumatic  
Bulldog Clamps**  
7 cm

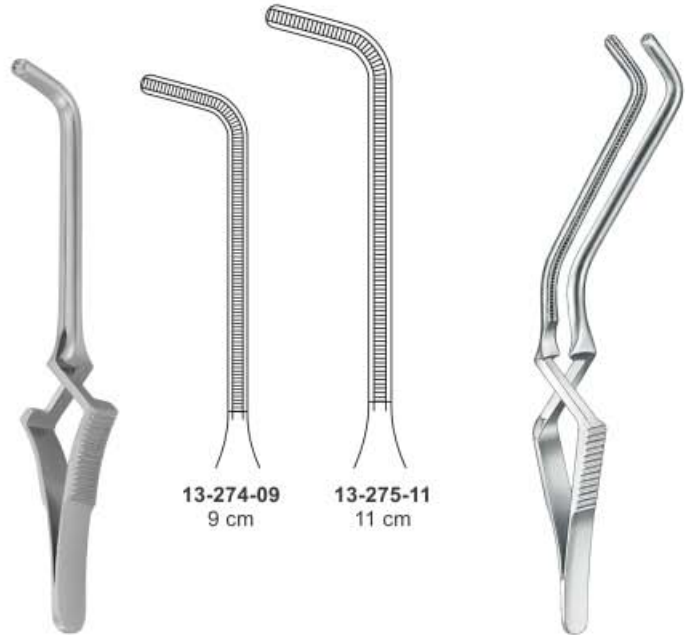

**Gregory-Soft Atraumatic  
Bulldog Clamps**

**Gregory  
13-276-10  
Bulldog Clamp**  
10.5 cm

**KUMMAS**  
CORPORATION

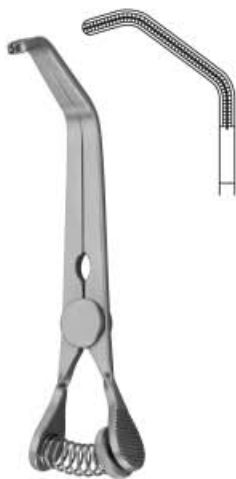

**De Bakey Atraumatic  
Bulldog Clamps  
Satinsky**  
13-277-07 7 cm



**De Bakey Atraumatic  
Bulldog Clamps  
Carotis**  
13-278-09 9 cm

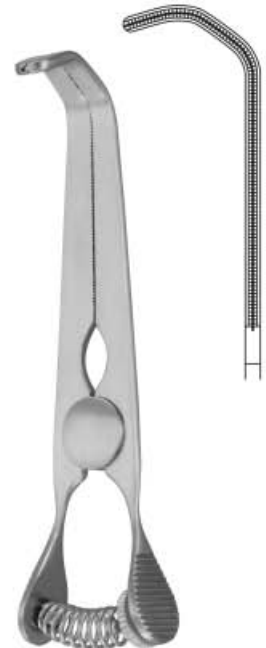

**De Bakey Atraumatic  
Bulldog Clamps  
Satinsky**  
13-279-10 10 cm

## BULLDOG CLAMPS

Bulldogklemmen	Clamps Bulldog
Clamps Bulldog	Pinze Bulldog

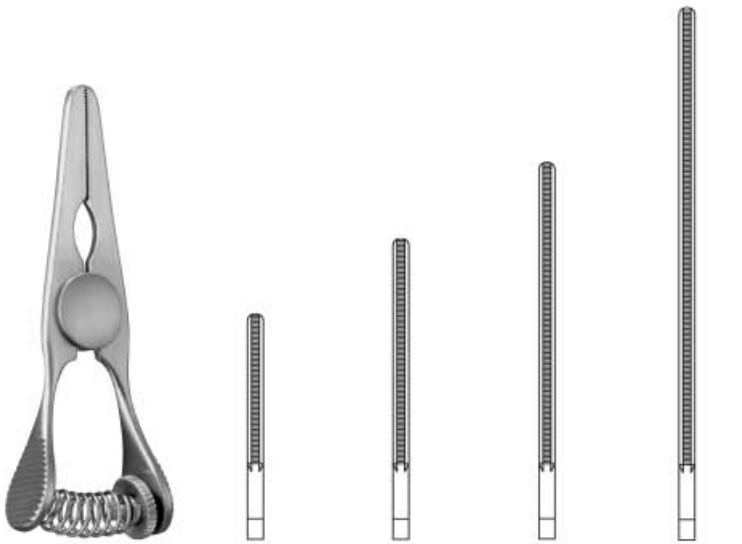

**Glover Atrauma Bulldog Clamps**  
cooley serrations with adjusting screw to regulate tension, Straight

<b>13-280-18</b> length 1.8 cm 7 cm, jaw	<b>13-281-32</b> length 3.2 cm 8 cm, jaw	<b>13-282-45</b> length 4.5 cm 8.5 cm, jaw	<b>13-283-60</b> length 6 cm 11 cm, jaw
--	--	--	---

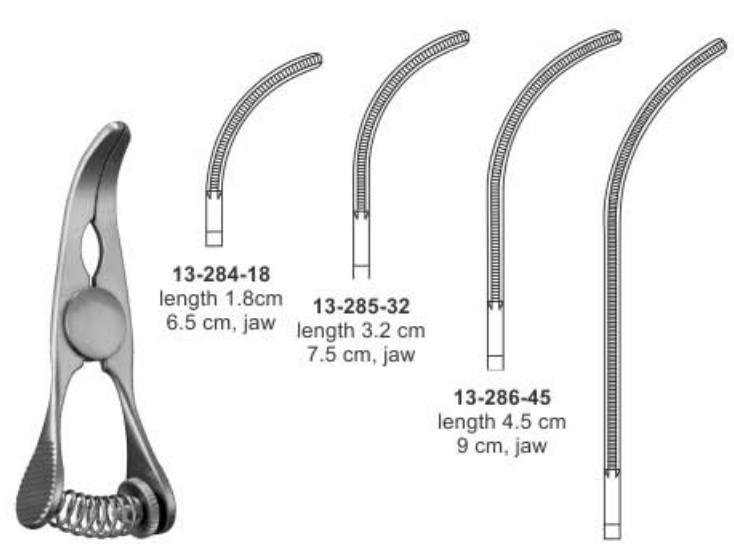

**Glover Atrauma Bulldog Clamps**  
cooley serrations with adjusting screw to regulate tension, curved

<b>13-284-18</b> length 1.8cm 6.5 cm, jaw	<b>13-285-32</b> length 3.2 cm 7.5 cm, jaw	<b>13-286-45</b> length 4.5 cm 9 cm, jaw	<b>13-287-60</b> length 6 cm 10.5 cm, jaw
---	--	--	---

KUMMAS  
CORPORATION



**Cooley Atrauma Bulldog Clamps**  
cooley serrations with adjusting screw to regulate tension, Straight

<b>13-288-20</b> 5.1 cm, jaw length 2 cm	<b>13-289-30</b> 6.7 cm, jaw length 3 cm	<b>13-290-47</b> 8.6 cm, jaw length 4.7 cm	<b>13-291-60</b> 13.3 cm, jaw length 6 cm
--	--	--	---



**Cooley Atrauma Bulldog Clamps**  
cooley serrations with adjusting screw to regulate tension, curved

<b>13-292-18</b> 4.4 cm, jaw length 1.8 cm	<b>13-293-24</b> 6.4 cm, jaw length 2.4 cm	<b>13-294-40</b> 7.6 cm, jaw length 4 cm	<b>13-295-52</b> 12.4 cm, jaw length 5.2 cm
--	--	--	---

## TITANIUM ATRAUMA BULLDOG CLAMPS

Atrauma Bulldog-Klemmen aus Titan  
Pincas Bulldog Atraumatiques en Titane

Abrazaderas Titanio Atrauma Bulldog  
Morsetti Bulldog Atrauma in Titanio



3 cm

Vene 13-296-30  
Arterie 13-297-30



3,5 cm

13-298-35  
13-299-35



4 cm

13-300-40  
13-301-40



5 cm

13-302-50  
13-303-50



3 cm

Vene 13-304-30  
Arterie 13-305-30



3,5 cm

13-306-35  
13-307-35



4 cm

13-308-40  
13-309-40



5 cm

13-310-50  
13-311-50

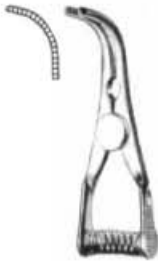

3 cm

Vene 13-312-30  
Arterie 13-313-30

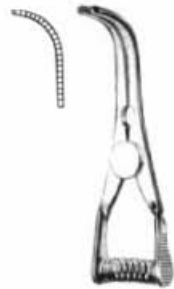

3,5 cm

13-314-35  
13-315-35



4 cm

13-316-40  
13-317-40

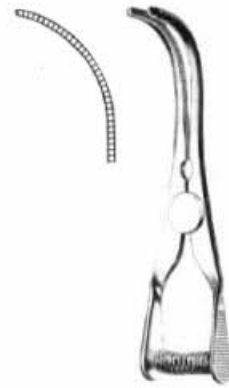

5 cm

13-318-50  
13-319-50



- 1.5 mm
- 13-320-12 12.5 cm
  - 13-321-14 14.5 cm
  - 13-322-16 16 cm
  - 13-323-20 20 cm
  - 13-324-24 24 cm

- 2.0 mm
- 13-325-12 12.5 cm
  - 13-326-14 14.5 cm
  - 13-327-16 16 cm
  - 13-328-20 20 cm
  - 13-329-24 24 cm
  - 13-330-30 30 cm

- 2.7 mm
- 13-331-16 16 cm
  - 13-332-20 20 cm
  - 13-333-24 24 cm
  - 13-334-30 30 cm

- 3.5 mm
- 13-335-16 16 cm
  - 13-336-20 20 cm
  - 13-337-24 24 cm
  - 13-338-30 30 cm
  - 13-339-35 35 cm

- 1.5 mm
- 13-340-14 14.5 cm Angled

- 2.0 mm
- 13-341-16 16 cm
  - 13-342-20 20 cm
  - 13-343-24 24 cm
  - 13-344-30 30 cm Angled

De Bakey Atraumatic Tissue Clamp Forceps

KUMMAS CORPORATION



- 1.2 mm
- 13-345-16T 16 cm
  - 13-346-20T 20 cm
  - 13-347-24T 24 cm

- 1.5 mm
- 13-348-16T 16 cm
  - 13-349-20T 20 cm
  - 13-350-20T 24 cm

- 1.8 mm
- 13-351-16T 16 cm
  - 13-352-20T 20 cm
  - 13-353-24T 24 cm

- 2.0 mm
- 13-354-16T 16 cm
  - 13-355-20T 20 cm
  - 13-356-24T 24 cm

- 2.8 mm
- 13-357-16T 16 cm
  - 13-358-20T 20 cm
  - 13-359-24T 24 cm

De Bakey Atraumatic Tissue Clamp Forceps Titanium

- 2.5 mm
- 13-360-15 15 cm
  - 13-361-20 20 cm
  - 13-362-24 24 cm stainless Steel

- 3.0 mm
- 13-363-15 15 cm
  - 13-364-20 20 cm
  - 13-365-24 24 cm stainless Steel

De Bakey Atraumatic Tissue Clamp Forceps





**Price-Thomas**  
Bronchus Clamp  
13-366-22 22 cm

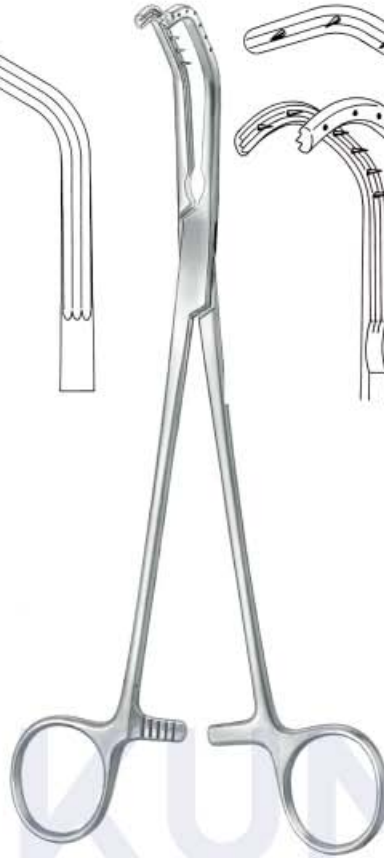

**Price-Thomas**  
Bronchus Clamp  
22 cm

13-367-01  
Fig.1

13-368-02  
Fig.2



**Sarat**  
Bronchus Clamp  
23cm

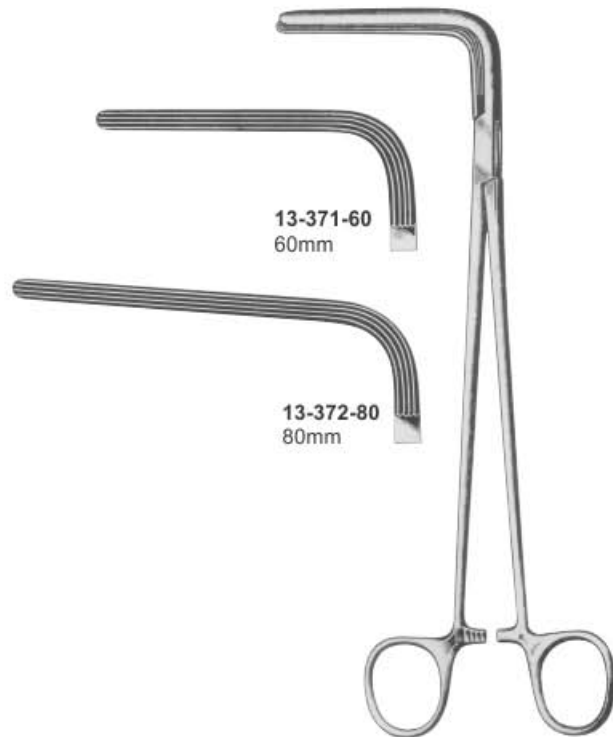

Bronchus clamp  
23cm

13-369-01

13-370-02

13-371-60  
60mm

13-372-80  
80mm



13-377-02  
Fig. 2

13-376-01  
Fig. 1

**Willauer**  
Dissecting Scissors  
13-373-28 28cm

**Crafoord**  
Lobectomy Scissors  
13-374-30 30cm

**Finochietto**  
Scissors  
13-375-27 27cm

**Semb**  
Bronchus Clamp  
25 cm

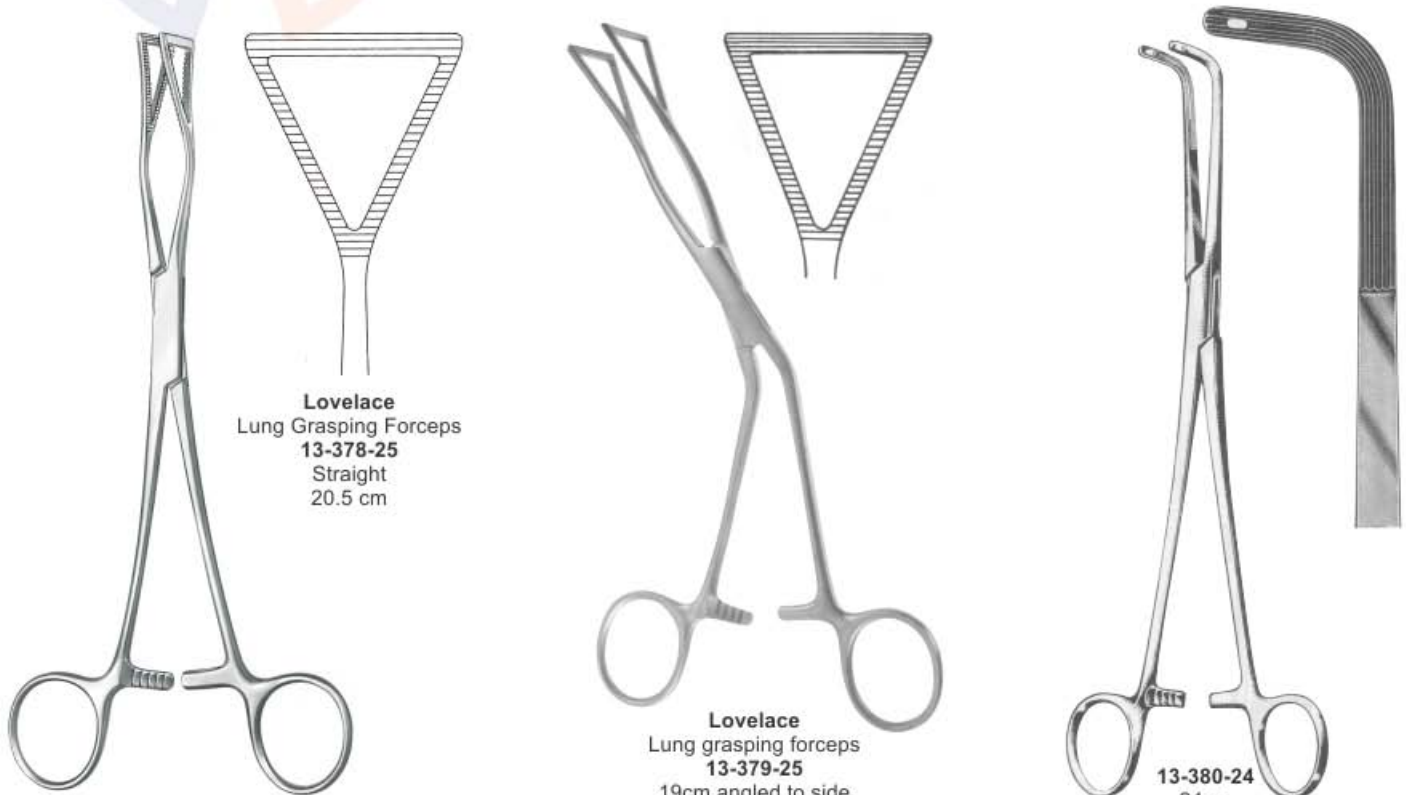

**Lovelace**  
Lung Grasping Forceps  
13-378-25  
Straight  
20.5 cm

**Lovelace**  
Lung grasping forceps  
13-379-25  
19cm angled to side  
jaws 25mm wide

13-380-24  
24cm  
**Finochietto**  
Thoracic And Ligature Forceps

Hemostatic forceps



**DeBakey-Mosquito  
Forceps**  
12.5cm

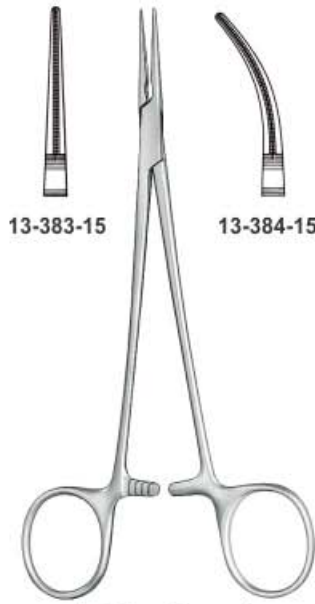

**DeBakey-Mosquito  
Forceps**  
15 cm

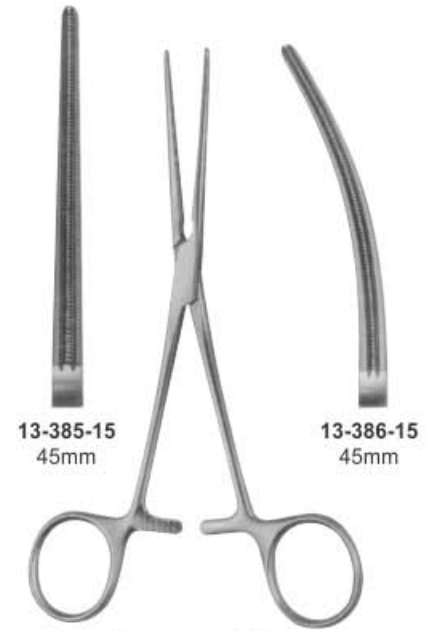

**DeBakey-PEAN  
Forceps**  
15.5cm

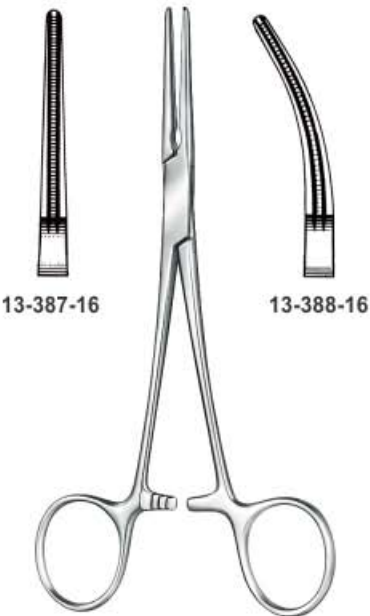

**DeBakey-Rankin  
Forceps**  
16cm



**De BAKEY-BAINBRIDGE**  
15.5cm



**De BAKEY-BAINBRIDGE**  
18cm

**KUMMAS**  
CORPORATION



De BAKEY  
13-393-16  
16.5cm



DeBaKey  
Multi purpose Vascular Clamp

13-394-16  
16.5 cm

13-395-16  
16.5 cm



DeBaKey  
13-396-16  
Multi purpose Vascular Clamp  
16.5 cm

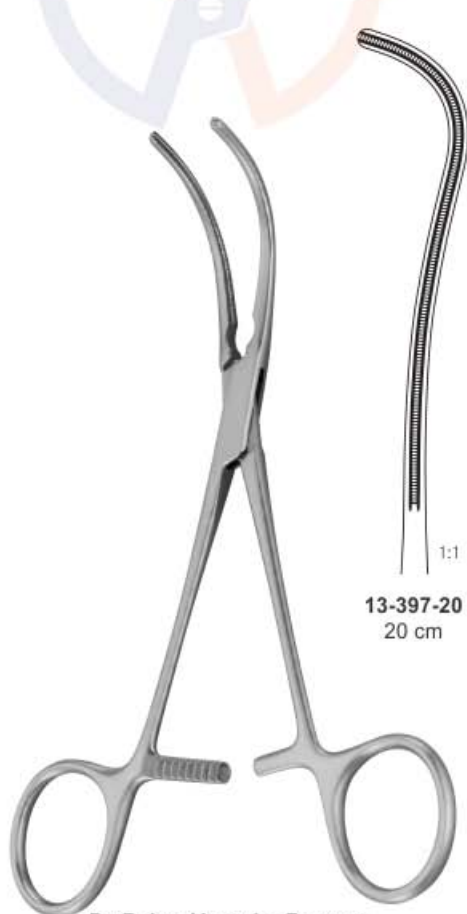

De Bakey Vascular Forceps



13-397-20  
20 cm



13-398-23  
23 cm



13-399-16  
16 cm

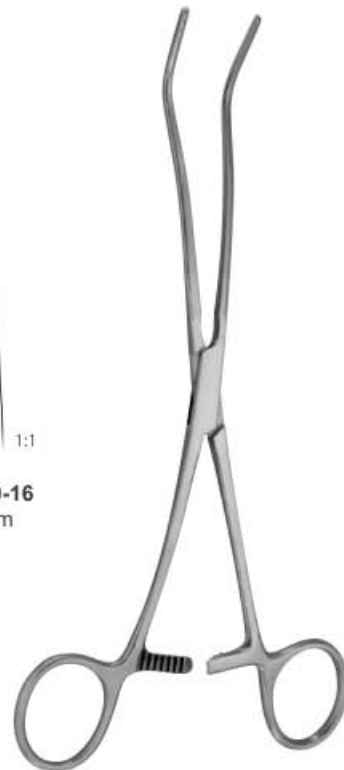

De Bakey Atraumatic Vascular Forceps



13-400-20  
20 cm  
S-curved



## BULLDOG CLAMPS, VASCULAR FORCEPS

Bulldog-Klemmen, Gefäßzangen | Abrazaderas Bulldog, Fórceps Vasculares  
 Pincas Bulldog, pincas vasculares | Morsetti Bulldog, pinza vascolare

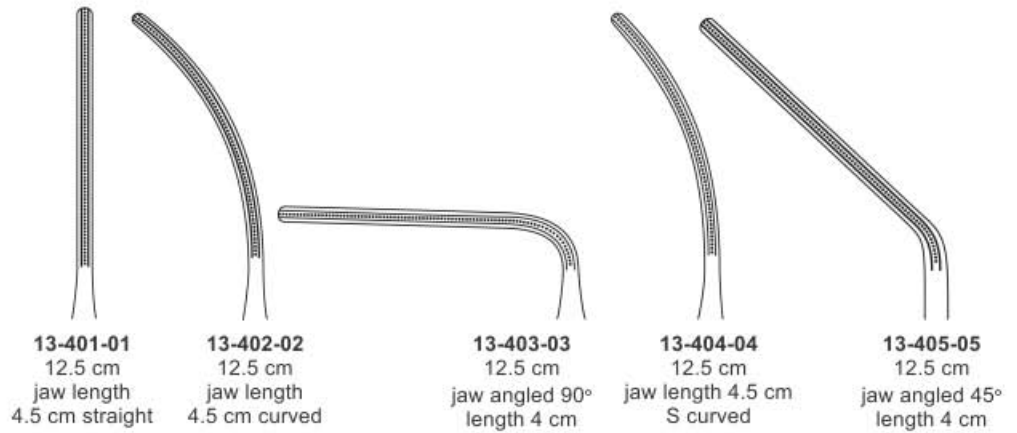

**13-401-01**  
12.5 cm  
jaw length  
4.5 cm straight

**13-402-02**  
12.5 cm  
jaw length  
4.5 cm curved

**13-403-03**  
12.5 cm  
jaw angled 90°  
length 4 cm

**13-404-04**  
12.5 cm  
jaw length 4.5 cm  
S curved

**13-405-05**  
12.5 cm  
jaw angled 45°  
length 4 cm

**Debakey Ring Handled Bulldog Clamps  
& Atraumatic Vascular Forceps**



**Debakey Miniature Clamps  
& Atraumatic Vascular Forceps**



**13-406-01**  
16.5 cm  
jaw length 2.9 cm  
straight jaws

**13-407-02**  
16.5 cm  
jaw length 2.9 cm  
jaws angled 30°

**13-408-03**  
16.5 cm  
jaw length 2.9 cm  
jaws angled 60°

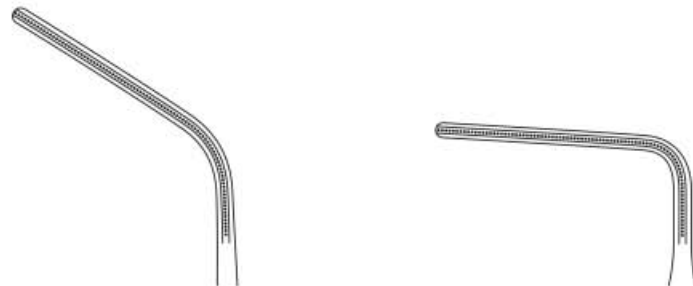

**13-409-04**  
16.5 cm  
jaw length 2.9 cm  
jaws angled 45°

**13-410-05**  
16.5 cm  
jaw length 2.9 cm  
jaws angled 90°

## MULTI-PURPOSE CLAMPS, PEDIATRIC

Mehrzweckklemmen, Pädiatrie  
Pincas multi-usages, pédiatriques

Abrazaderas multiusos, pediátricas  
Morsetti multiuso, pediatrici



**Cooley Multipurpose Clamp & Atraumatic Cardiovascular Forceps**

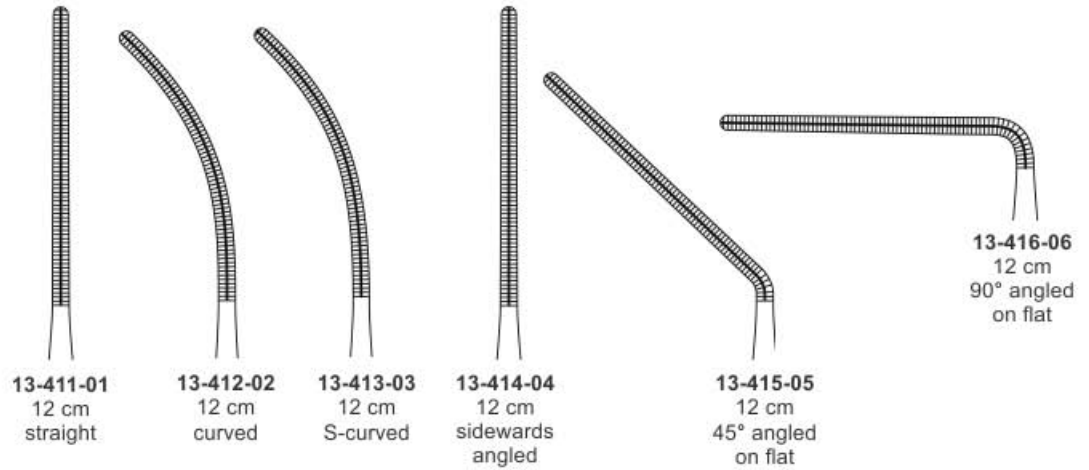

KUMMAS  
CORPORATION

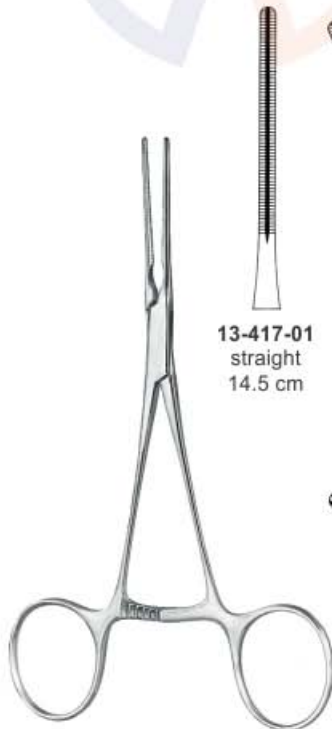

**Cooley Pediatric Vascular Clamp**  
14.5 cm

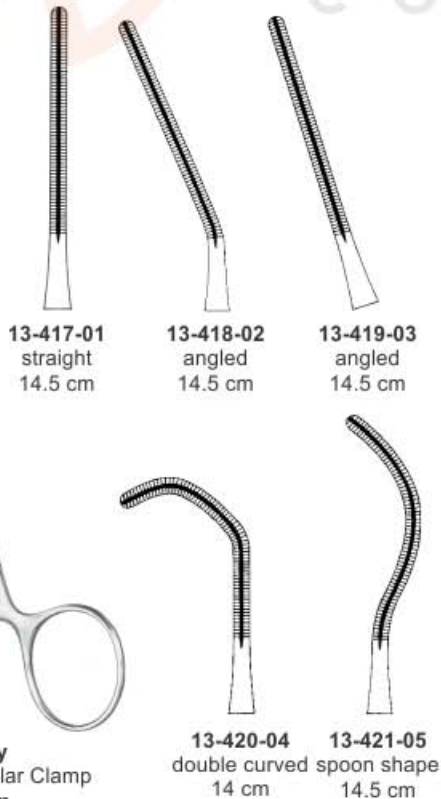

**Cooley Multipurpose Clamp & Atraumatic Cardiovascular Forceps**

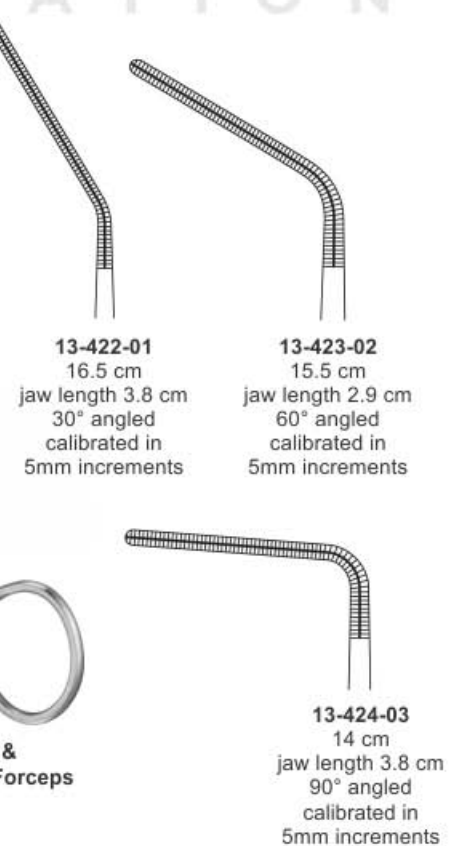

## Cooley Multipurpose Clamp & Atraumatic Cardiovascular Forceps

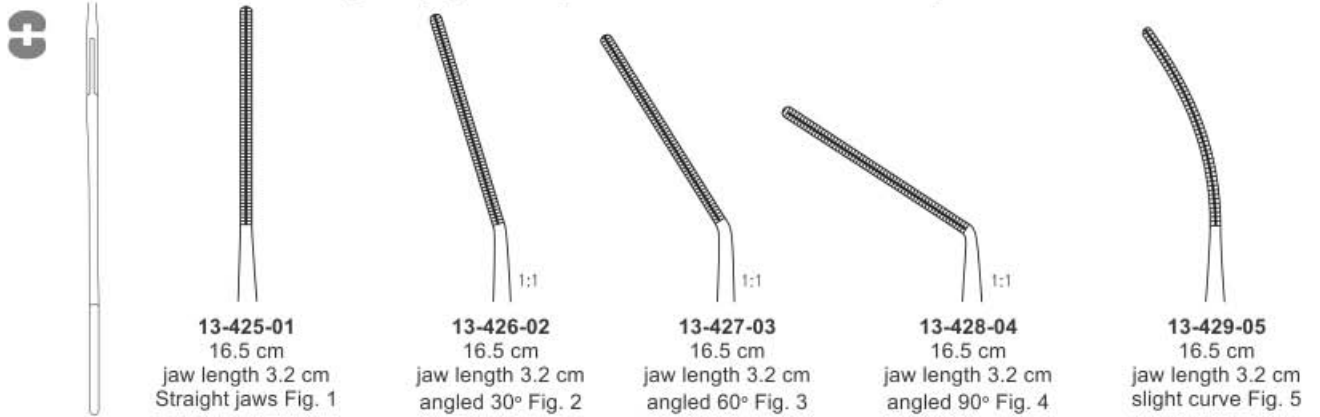

## Cooley Double Angled Vascular Clamp & Atraumatic Cardiovascular Forceps



## Cooley Multipurpose Clamp & Atraumatic Cardiovascular Forceps

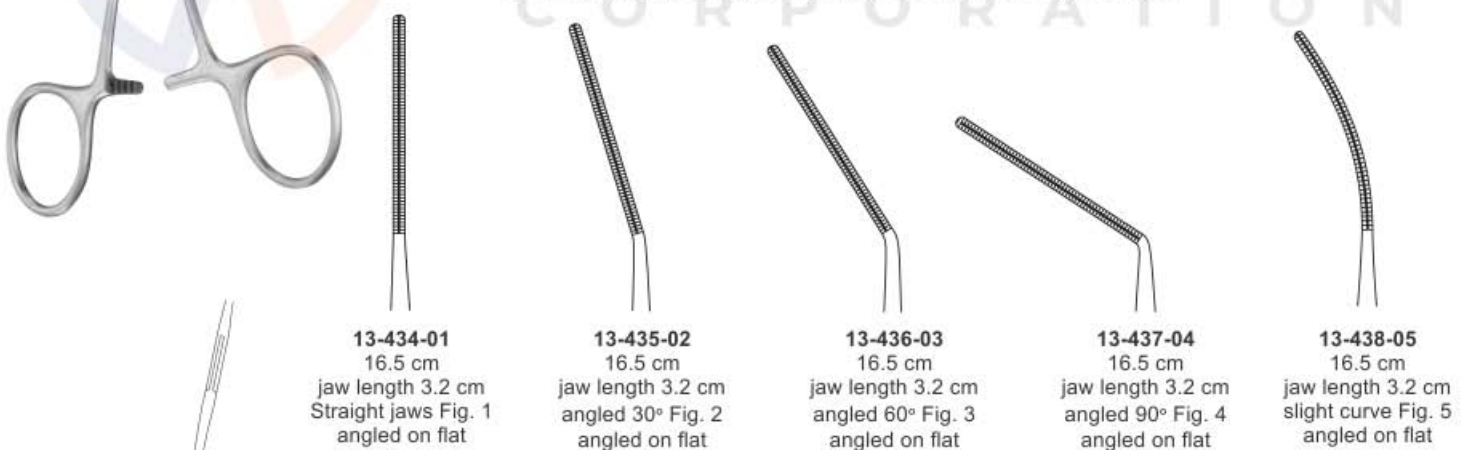

## Cooley Double Angled Vascular Clamp & Atraumatic Cardiovascular Forceps

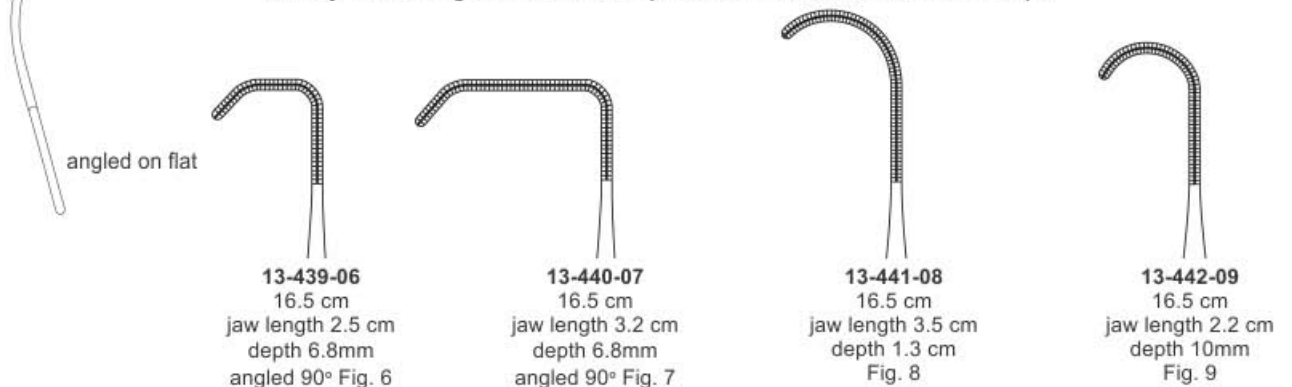





**Cooley**  
Multi purpose Vascular Clamp  
**13-443-17**  
17 cm



**Cooley**  
Multi purpose Vascular Clamp  
curved  
**13-444-17** 17 cm

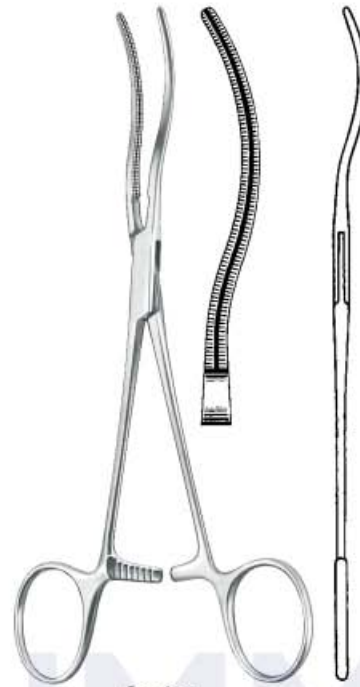

**Cooley**  
Multi purpose Vascular Clamp  
**13-445-17**  
17.5 cm

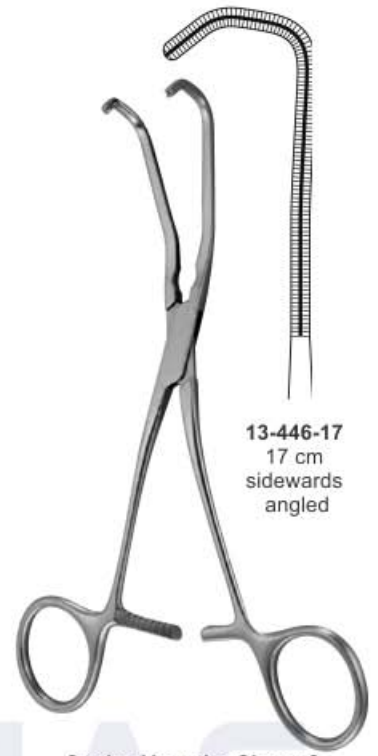

**Cooley Vascular Clamp & Atraumatic Cardiovascular Forceps**  
**13-446-17**  
17 cm  
sideways angled



**Cooley**  
Anastomosis Clamp  
**13-447-17**  
17 cm

KUMMAS CORPORATION



**Cooley Neonatal Vascular clamp**  
12.7cm  
**13-448-01** 3.8cm straight jaws, straight shanks  
**13-449-02** 3.8cm angled shanks, straight jaws  
**13-450-03** 3.8cm curved shanks, angled jaws  
**13-451-04** 3.8cm straight shanks, full curved jaws



**Cooley Neonatal Vascular clamp**  
**13-452-12** 12 cm  
jaw length 2.9 cm  
straight shanks,  
partial occlusion jaws





**Cooley Vascular Clamp & Atraumatic Cardiovascular Forceps**

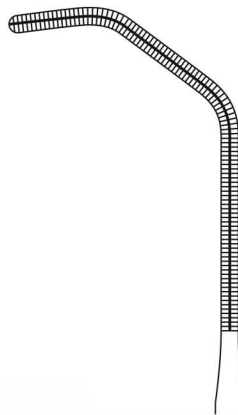

**13-453-01**  
16.5 cm  
jaw length 3.2 cm  
jaw depth 7mm  
angled 60° small

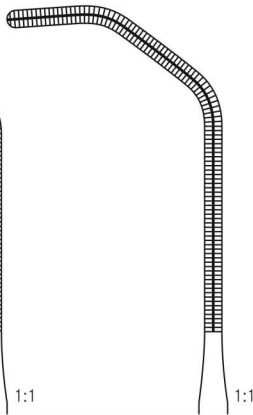

**13-454-02**  
16.5 cm  
jaw length 3.7 cm  
jaw depth 7mm  
angled 60° large

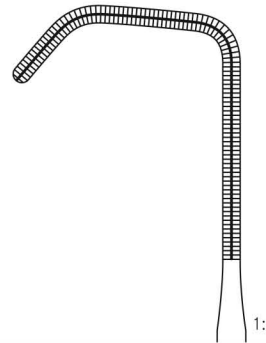

**13-455-03**  
16.5 cm  
jaw length 2.7 cm  
jaw depth 7mm  
angled 90° small

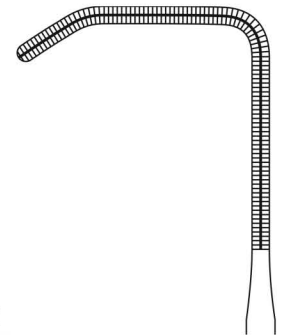

**13-456-04**  
16.5 cm  
jaw length 3.2 cm  
jaw depth 7mm  
angled 60° large



**Castaneda Multipurpose Clamp & Atraumatic Cardiovascular Forceps**

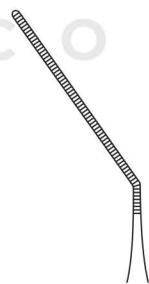

**13-457-30**  
12.7 cm  
jaw length 3.5 cm  
jaw angled 30°

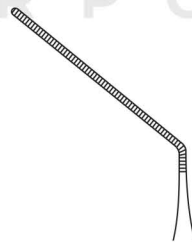

**13-458-50**  
12.7 cm  
jaw length 3.5 cm  
jaw angled 50°

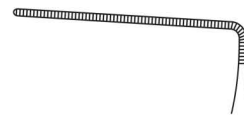

**13-459-90**  
12.7 cm  
jaw length 3.5 cm  
jaw angled 90°

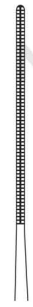

**13-460-00**  
12.7 cm  
jaw length 3.5 cm  
straight

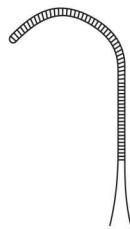

**13-461-01**  
14.6 cm  
jaw length 1.5 cm  
depth 5mm



**13-462-02**  
15.2 cm  
jaw length 1.8 cm  
depth 6mm



**13-463-03**  
15.6 cm  
jaw length 2.1 cm  
depth 7mm

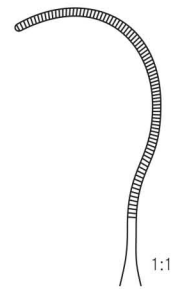

**13-464-04**  
12.4 cm  
jaw length 2.4 cm  
depth 8mm  
spoon-shape

## MULTI-PURPOSE CLAMPS, CARDIOVASCULAR FORCEPS

Mehrzweckklemmen, Herz-Kreislauf-Zange | Pinzas multiusos, pinzas cardiovasculares  
 Pinces multi-usages, pincas cardiovasculaires | Morsetti multiuso, pinze cardiovascolari

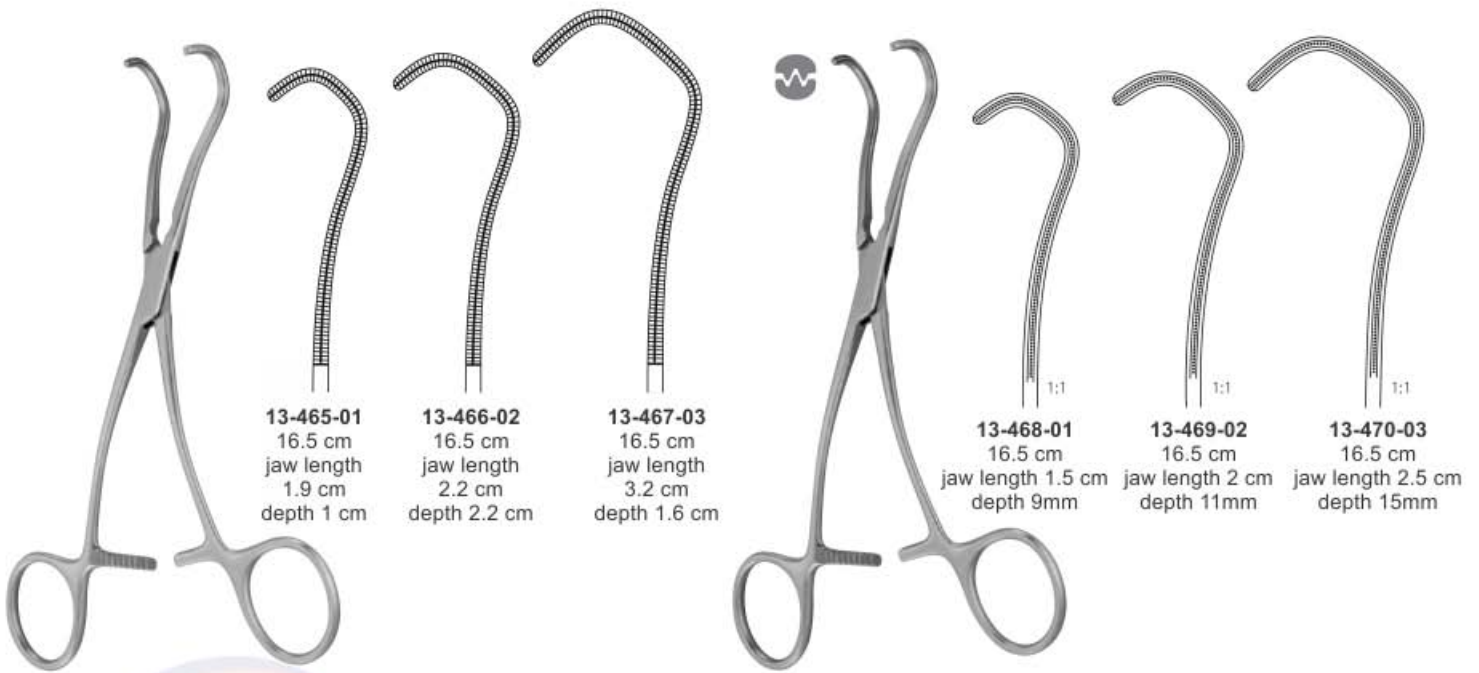

**Cooley - Derra Vascular Clamp & Atraumatic Cardiovascular Forceps**

**Derra Anastmosis Clamps & Atraumatic Vascular Forceps**

**13-465-01**  
16.5 cm  
jaw length  
1.9 cm  
depth 1 cm

**13-466-02**  
16.5 cm  
jaw length  
2.2 cm  
depth 2.2 cm

**13-467-03**  
16.5 cm  
jaw length  
3.2 cm  
depth 1.6 cm

**13-468-01**  
16.5 cm  
jaw length 1.5 cm  
depth 9mm

**13-469-02**  
16.5 cm  
jaw length 2 cm  
depth 11mm

**13-470-03**  
16.5 cm  
jaw length 2.5 cm  
depth 15mm



**Beck Aorta Clamps & Atraumatic Vascular Forceps**

**13-471-01**  
17 cm  
straight shanks  
jaw length  
2 cm  
depth 8mm

**13-472-02**  
20 cm  
straight shanks  
jaw length  
3 cm  
depth 8mm

**13-473-03**  
21.3 cm  
straight shanks  
jaw length  
4.5 cm  
depth 1cm

**13-474-04**  
21.6 cm  
straight shanks  
jaw length 6.7cm  
depth 1cm

## PERIPHERAL VASCULAR CLAMP, COARCTATION FORCEPS

Periphere Gefäßklemme, Koarktationszange

Pinza vascular periférica, fórceps de coartación

Pince vasculaire périphérique, pince à coarctation

Morsetto vascolare periferico, pinza di coartazione



**13-475-20**  
20 cm  
jaw length  
30mm,  
straight shanks

**Potts Atraumatic Tissue  
Clamp Forceps**



**13-476-22**  
22 cm  
jaw length  
50mm,  
straight shanks



**13-477-20**  
20 cm  
jaw length  
30mm,  
angled shanks



**13-478-22**  
22 cm  
jaw length  
50mm,  
angled shanks



**13-479-20**  
20 cm



**13-480-22**  
22 cm  
jaw length 30mm  
spoon shaped  
jaws



**Potts Atraumatic Tissue  
Clamp Forceps**

KUMMAS  
CORPORATION



**Husfeldt**  
Peripheral Vascular Clamp  
**13-481-18** 18 cm



**Husfeldt**  
Peripheral Vascular Clamp  
**13-482-18** 18 cm



**Husfeldt**  
Peripheral Vascular Clamp  
**13-483-18** 18 cm



**Cooley Multipurpose Clamps**  
calibrated in 5mm increments



**13-484-90**  
14 cm  
jaw length  
3.8 cm  
angled 90°

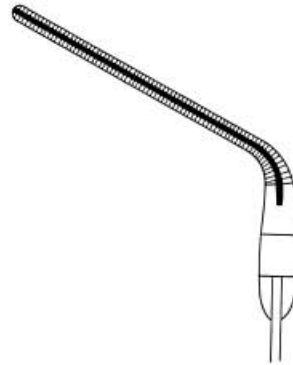

**13-485-60**  
15.6 cm  
jaw length  
2.9 cm  
angled 60°



**13-486-30**  
16.5 cm  
jaw length  
3.8 cm  
angled 30°

KUMMAS  
CORPORATION



**Cooley Multipurpose Curved Clamps**

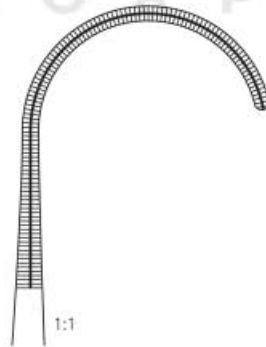

**13-487-16**  
16cm  
**13-488-20**  
20 cm  
jaw length 3.2 cm  
depth 1.6 cm  
calibrated in 5mm increments

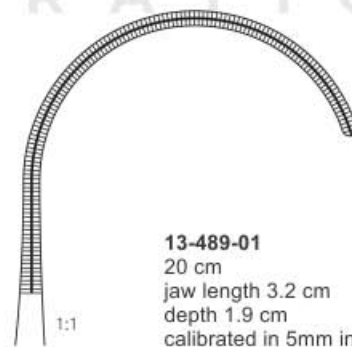

**13-489-01**  
20 cm  
jaw length 3.2 cm  
depth 1.9 cm  
calibrated in 5mm increments

**13-490-02**  
24 cm  
jaw length 3.8 cm  
half the distance from  
the distal tip

**13-491-03**  
23 cm  
jaw length 5.4 cm  
half the distance from  
the distal tip

**13-492-04**  
24 cm  
jaw length 3.8 cm  
angled 60°  
the distal tip



C

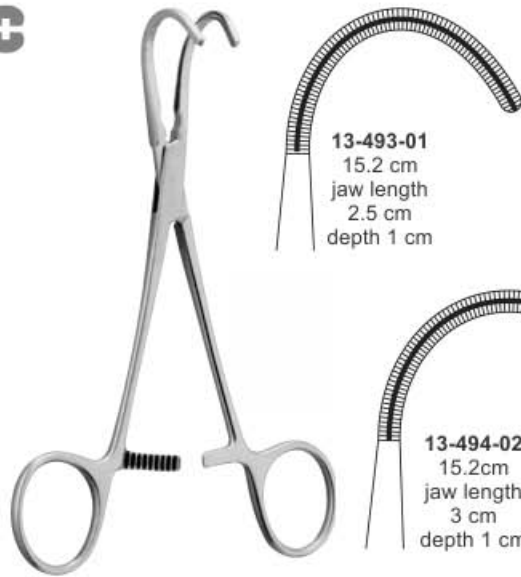

**13-493-01**  
15.2 cm  
jaw length  
2.5 cm  
depth 1 cm

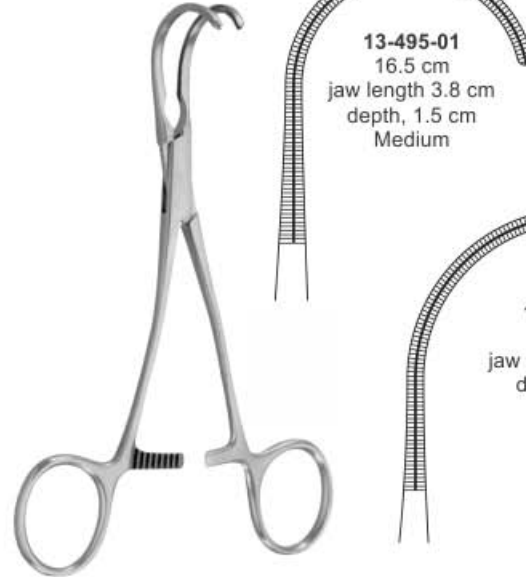

**13-495-01**  
16.5 cm  
jaw length 3.8 cm  
depth, 1.5 cm  
Medium

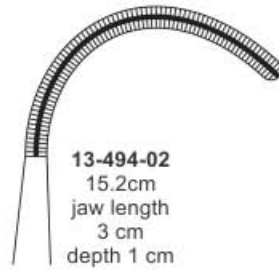

**13-494-02**  
15.2cm  
jaw length  
3 cm  
depth 1 cm

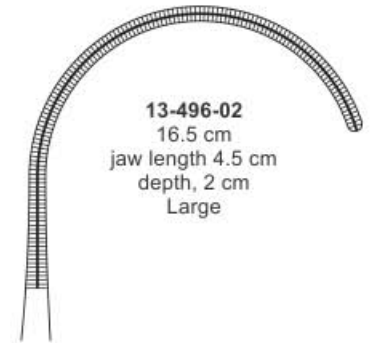

**13-496-02**  
16.5 cm  
jaw length 4.5 cm  
depth, 2 cm  
Large

**Cooley Beck Vessel Clamps & Atraumatic Cardiovascular Forceps**

**Cooley Acutely Curved Clamps & Atraumatic Cardiovascular Forceps**

KUMMAS CORPORATION



**13-497-01**  
17 cm  
jaw length  
3.8 cm  
straight



**13-498-02**  
17 cm  
jaw length  
3.8 cm  
curved



**13-499-03**  
17 cm  
jaw length  
3.8 cm  
S curved



**Cooley Coarctation Clamp**  
**13-500-17** 17 cm  
jaw length 3.8 cm  
angled shank

**Cooley Coarctation Clamp**

## MULTI-PURPOSE CLAMPS, CARDIOVASCULAR FORCEPS

Mehrzweckklemmen, Herz-Kreislauf-Zange | Pinzas multiusos, pinzas cardiovasculares  
 Pinces multi-usages, Pinces cardiovasculaires | Morsetti multuso, pinze cardiovascolari

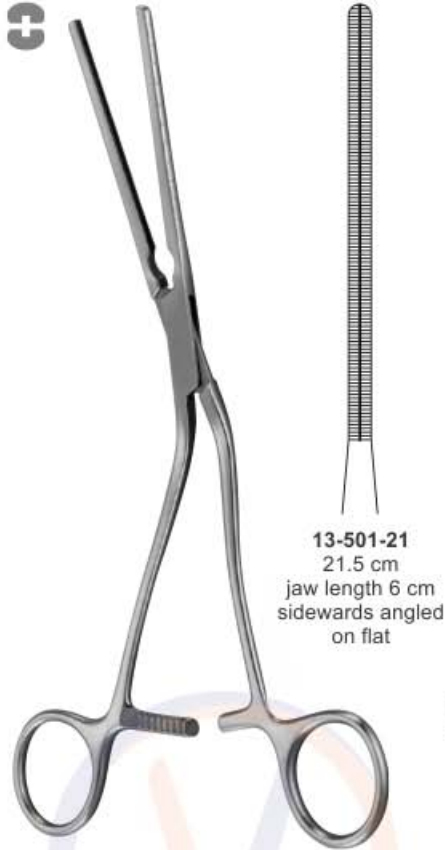

Cooley Liac Forceps & Atraumatic Cardiovascular Forceps

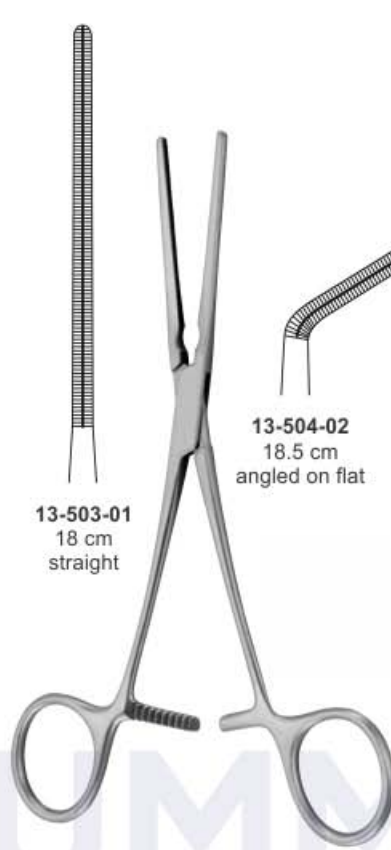
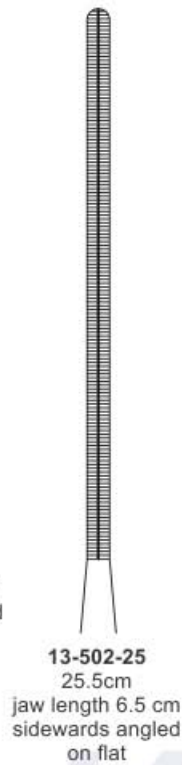

Cooley & Atraumatic Cardiovascular Forceps

13-504-02  
18.5 cm  
angled on flat



Cooley - Partial Occlusion Clamps & Atraumatic Cardiovascular Forceps

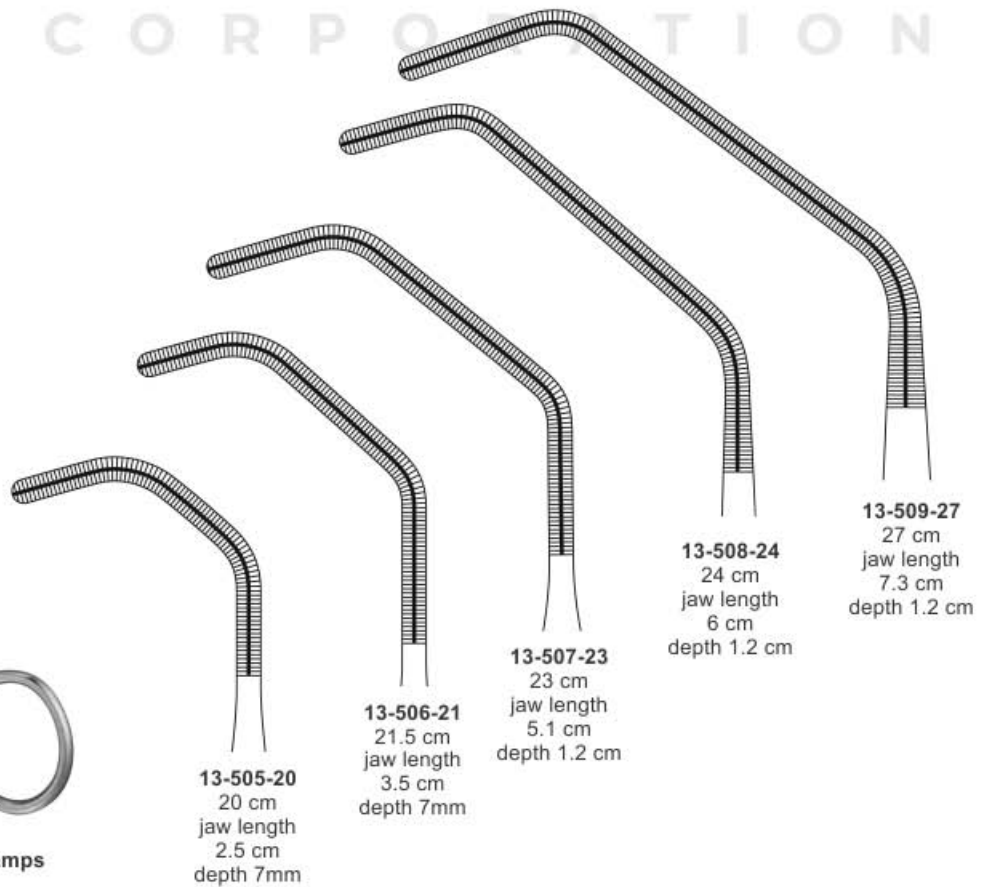



**Cooley Patent Ductus Clamp & Atraumatic Cardiovascular Forceps**  
13-510-16 16 cm  
jaw length 3.2 cm  
straight shanks  
13-511-22 22 cm  
jaw length 3 cm  
straight shanks

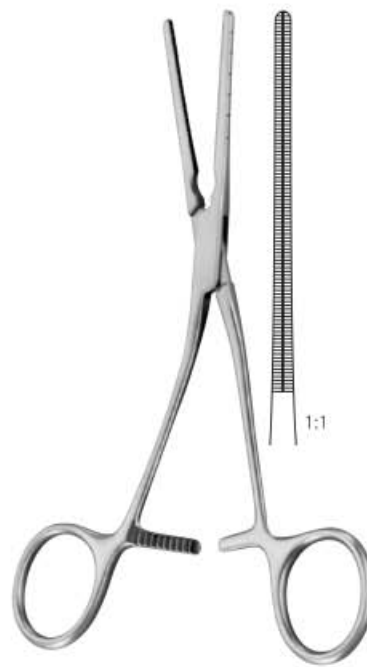

**Cooley Patent Ductus Clamp & atraumatic cardiovascular forceps**  
angled on flat, graduated  
13-512-16 16 cm  
jaw length 3.2 cm  
angled shanks, calibrated  
in 5mm increments  
13-513-22 22 cm  
jaw length 3cm angled  
shanks, calibrated in  
5mm increments



**Debaquey Coarctation Vascular clamps**  
13-514-23 23 cm  
jaw length 5.4 cm  
straight shank

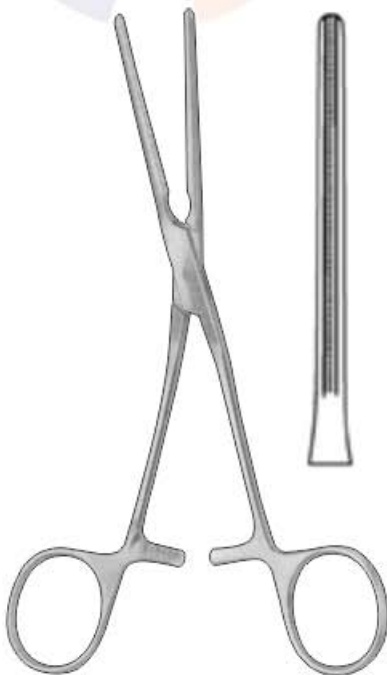

**Debaquey Coarctation Vascular clamps**  
13-515-23 23 cm  
jaw length 5.4 cm  
angled shank



**Debaquey Patent Ductus Clamp**  
13-516-20 20 cm  
jaw length 3 cm  
straight shank



**Debaquey Patent ductus clamp**  
13-517-20 20 cm  
jaw length 3 cm  
angled shank



## VASCULAR FORCEPS

Gefäßklemmen | Pinzas vasculares  
Pinces vasculaires | Pinze vascolari

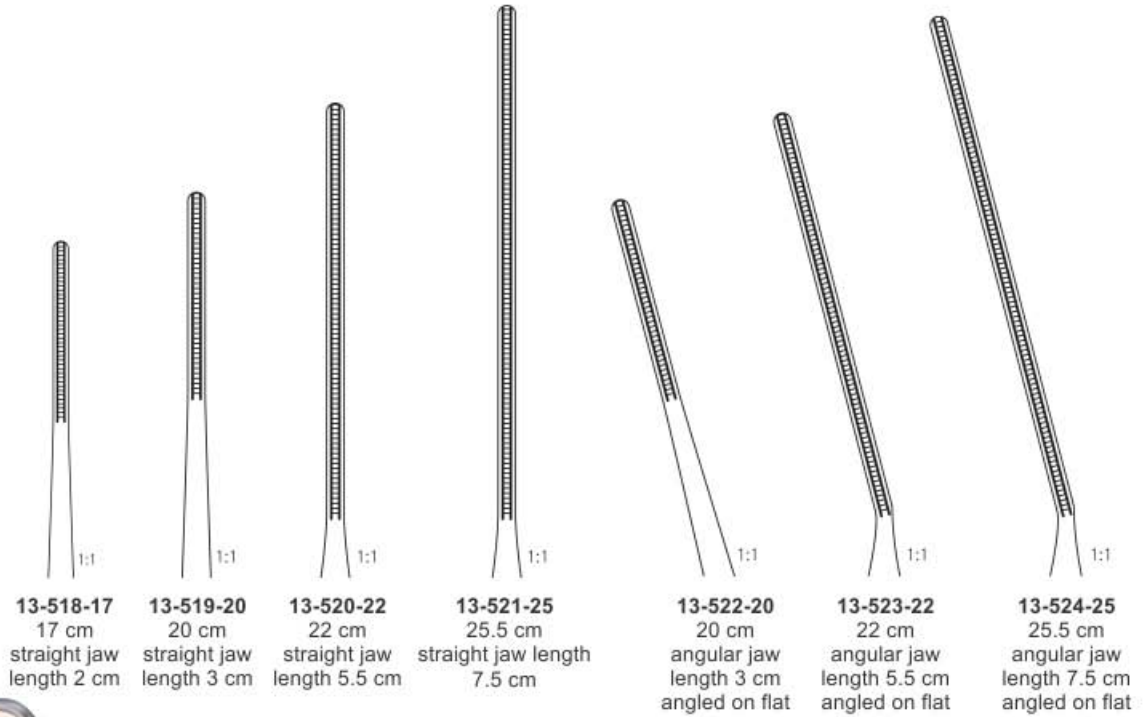

Glover Clamp & Atraumatic Vascular Forceps

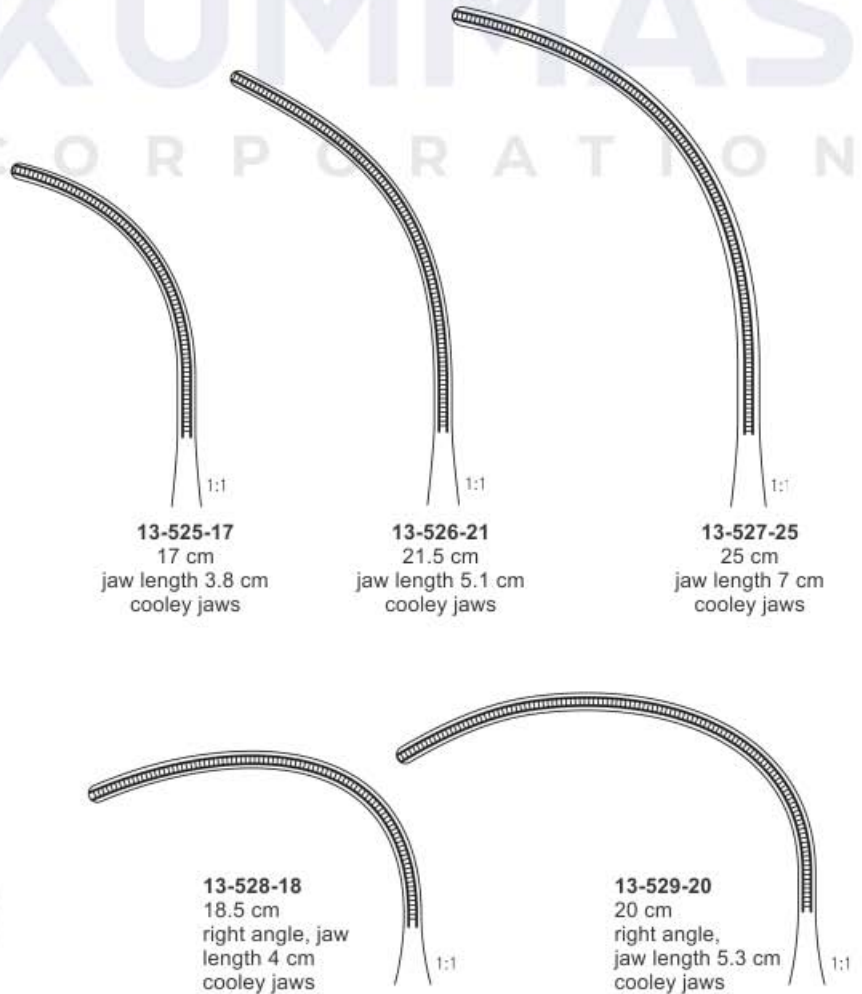

Glover Clamp & Atraumatic Vascular Forceps Curved



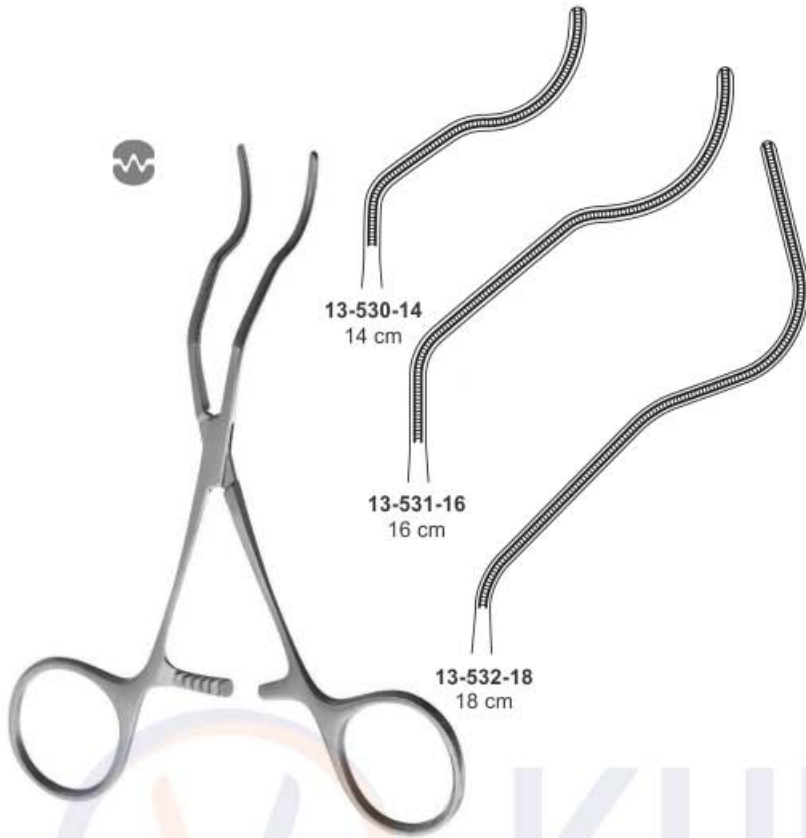

**Gregory Profunda Clamps  
& Atraumatic Vascular Forceps**



**Martin  
Peripheral Vascular Clamp  
13-533-16 16.5 cm**

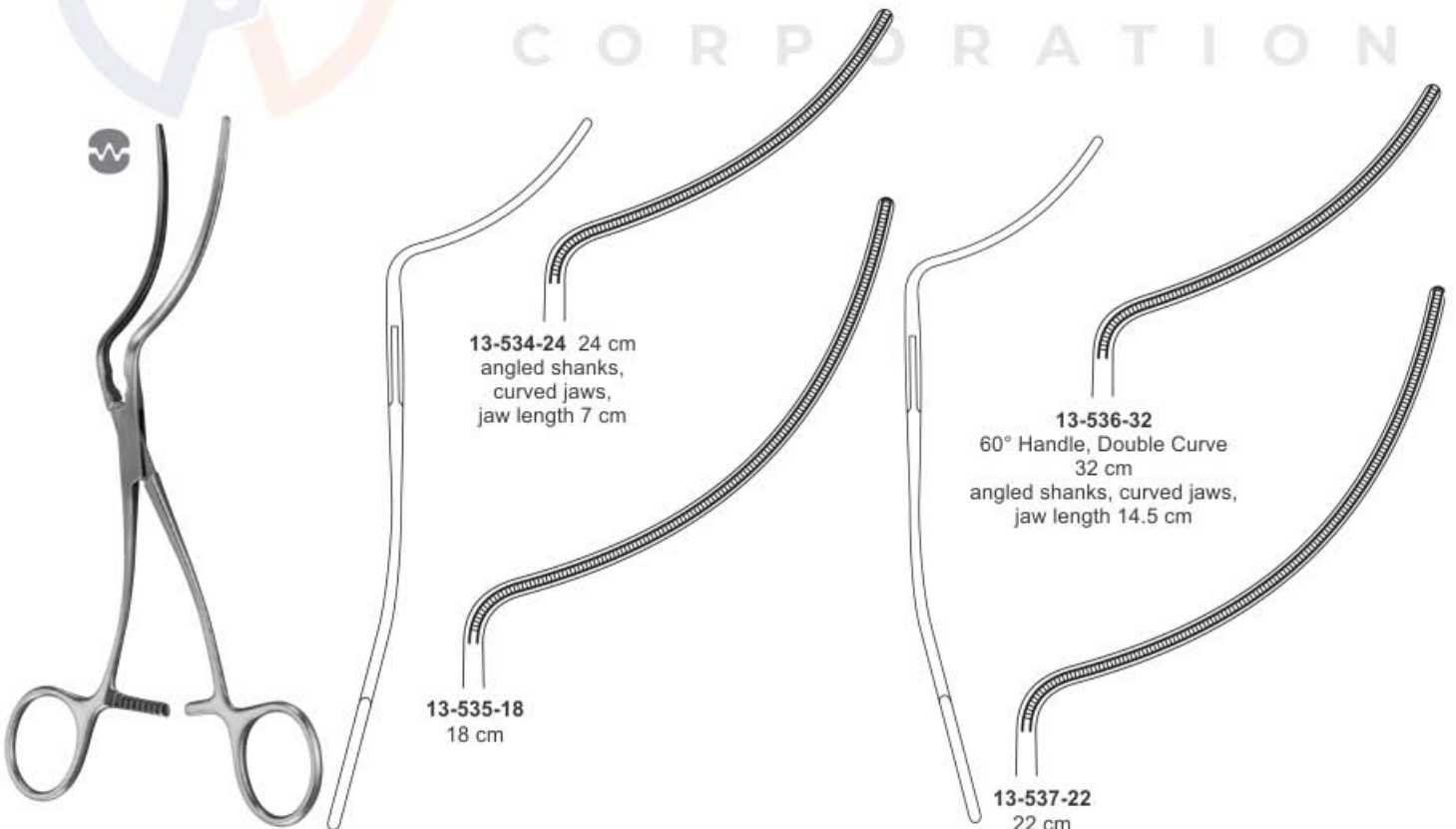

**De Bakey-Wylie Hypogastric Clamp  
& Atraumatic Vascular Forceps**

**Cherry Supraceliac Clamp  
& Atraumatic Vascular Forceps**

## VENA CAVA CLAMPS, AORTA CLAMP

Vena-Cava-Klemmen, Aorta-Klemme | Abrazaderas de vena cava, abrazadera de aorta  
 Pincas de veine cave, pince d'aorte | Morsetti Vena Cava, Morsetto Aorta



**Satinsky Pediatric Clamp,**  
**13-538-14** 14 cm  
 jaw length 2.5 cm  
 depth 5mm, cooley jaws,



**Cooley Aorta Clamp**  
**13-539-20** 20 cm  
 jaw length 4.7 cm  
 depth 1.3 cm  
 curved shanks



**Parsonnet Aorta Clamp**  
 26 cm  
**13-540-01** 2.8 cm jaw length  
**13-541-02** 3.2 cm jaw length  
**13-542-03** 3.8 cm jaw length  
**13-543-04** 4.4 cm jaw length



**Satinsky Vena Cava Clamps**  
 cross serrated jaws  
**13-544-01** 25.5cm jaw length  
 4.4 cm depth 1.3 cm  
**13-545-02** 25.5 cm  
 jaw length 3.2 cm  
 depth 9mm



**Debaquey Satinsky clamps**  
**13-546-01** 25.5cm jaw length 5.1 cm  
 depth 0.9 cm small jaws  
**13-547-02** 25.5 cm jaw length 5.4 cm  
 depth 1.9 cm small jaws  
**13-548-03** 25.5 cm jaw length 6 cm  
 depth 1.9 cm small jaws

## AORTA CLAMP & VASCULAR FORCEPS

Aortenklamme & Gefäßzange

Pinza de aorta y pinzas vasculares

Pince aortique et pince vasculaire

Morsetto aortico e pinza vascolare

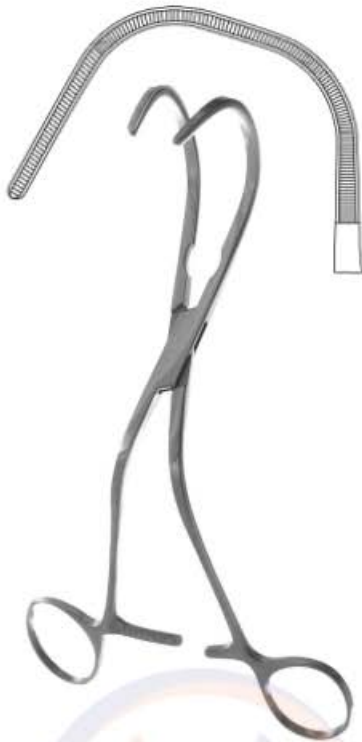

**Lambert-Kay Aorta Amastomosis Clamps**

20 cm  
**13-549-01** jaw length 4.5 cm  
 depth 3.2 cm  
**13-550-02** jaw length 4.5 cm  
 depth 4.5 cm



**Lambert-Kay Aorta Clamp  
 & Atraumatic Vascular Forceps**

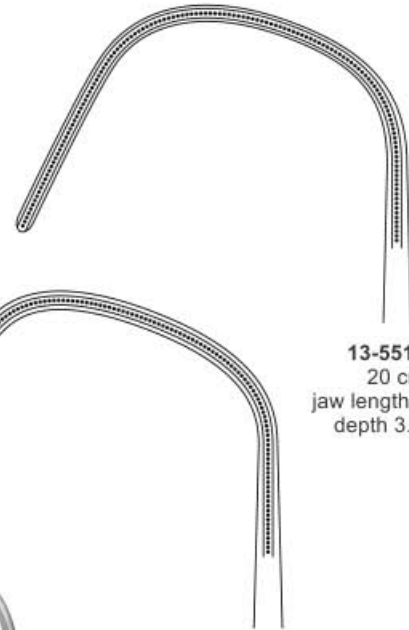

**13-551-01**  
 20 cm  
 jaw length 4.5 cm  
 depth 3.2 cm

**13-552-02**  
 20 cm  
 jaw length 4.5 cm  
 depth 4.9 cm

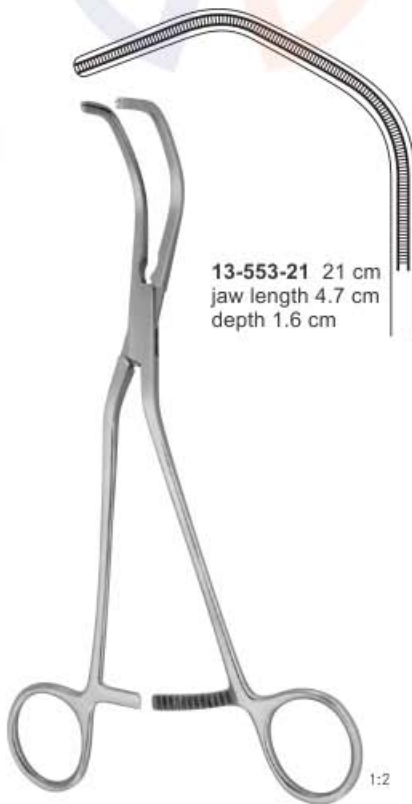

**13-553-21** 21 cm  
 jaw length 4.7 cm  
 depth 1.6 cm

**Diethrich Aorta Clamp  
 & Atraumatic Vascular Forceps**

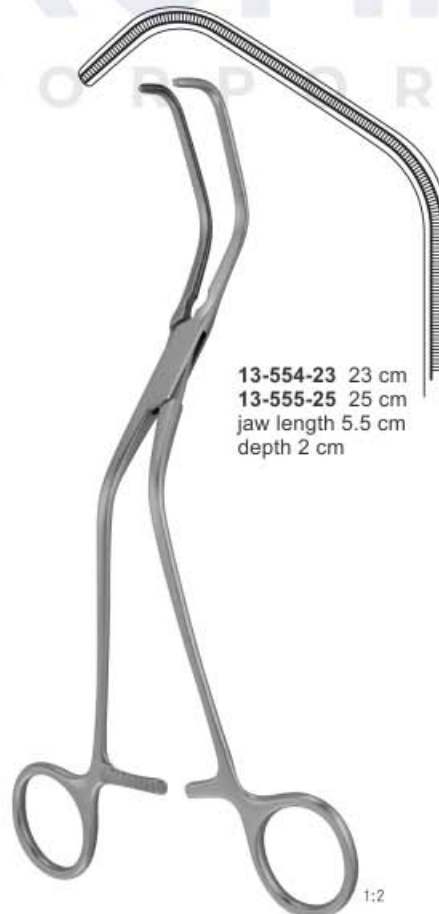

**13-554-23** 23 cm  
**13-555-25** 25 cm  
 jaw length 5.5 cm  
 depth 2 cm

**Ochsner Aorta Clamp &  
 Atraumatic Vascular Forceps**



**Lemole-Strong Aorta Clamp**  
 21 cm  
**13-556-01** jaw length 4.4 cm  
 depth 2.2cm straight shanks  
**13-557-02** jaw length 4.4 cm  
 depth 2.2 cm straight shanks



## TANGENTIAL VASCULAR FORCEPS

Tangentiale Gefäßzange	Pinzas vasculares tangenciales
Pince vasculaire tangentielle	Forcipe vascolare tangenziale



**Debakey Tangential Occlusion Clamps & Atraumatic Vascular Forceps**



**13-558-20** 20 cm  
jaw length 3.5 cm  
depth 1.1 cm

**13-559-26** 26 cm  
jaw length 4.8 cm  
depth 1.6 cm

**13-560-27** 27 cm  
jaw length 5.5 cm  
depth 1.5 cm

**13-561-37** 27.5 cm  
jaw length 6 cm  
depth 1.4 cm

**13-562-28** 28 cm  
jaw length 7.5 cm  
depth 1.7 cm



**Uro-Tangential Tangential Forceps**

**13-563-25**  
25 cm

**13-564-27**  
27 cm

**Cooly Tangential Occlusion Clamps**

double angled jaws calibrated  
in 5mm increments 19.7 cm  
**13-565-01** jaw length 1.9 cm depth 6mm  
**13-566-02** jaw length 2.5 cm depth 7mm  
**13-567-03** jaw length 3.5 cm depth 10mm







**13-568-24**  
24 cm  
jaw length 7.5 cm  
straight jaw



**13-569-27**  
27 cm  
jaw length 8.5 cm  
straight jaw

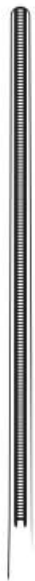

**13-570-30**  
30 cm  
jaw length 10 cm  
straight jaw



**13-571-31**  
31 cm  
jaw length 12 cm  
straight jaw



**13-572-24**  
24 cm  
jaw length 7.5 cm  
slightly curved jaw



**13-573-27**  
27 cm  
jaw length 8.5 cm  
slightly curved jaw



**13-574-30**  
30 cm  
jaw length 10 cm  
slightly curved jaw



**13-575-31**  
31 cm  
jaw length 12 cm  
slightly curved jaw



**Debakey Aortic Aneurysm Clamps & Atraumatic Vascular Forceps**

KUMMAS CORPORATION



**13-576-24**  
24 cm  
jaw length 7.5 cm,  
C-Curved



**13-577-26**  
26.5 cm  
jaw length 8.5 cm,  
C-Curved



**13-578-30**  
30 cm  
jaw length 10 cm,  
C-Curved



**13-579-31**  
31 cm  
jaw length 12 cm,  
C-Curved



**De Bakey Aortic Aneurysm Clamps & Atraumatic Vascular Forceps**



**De Bakey Atraumatic Vascular Forceps**  
13-580-28 28 cm



**De Bakey Multipurpose Clamp  
& Atraumatic Vascular Forceps**

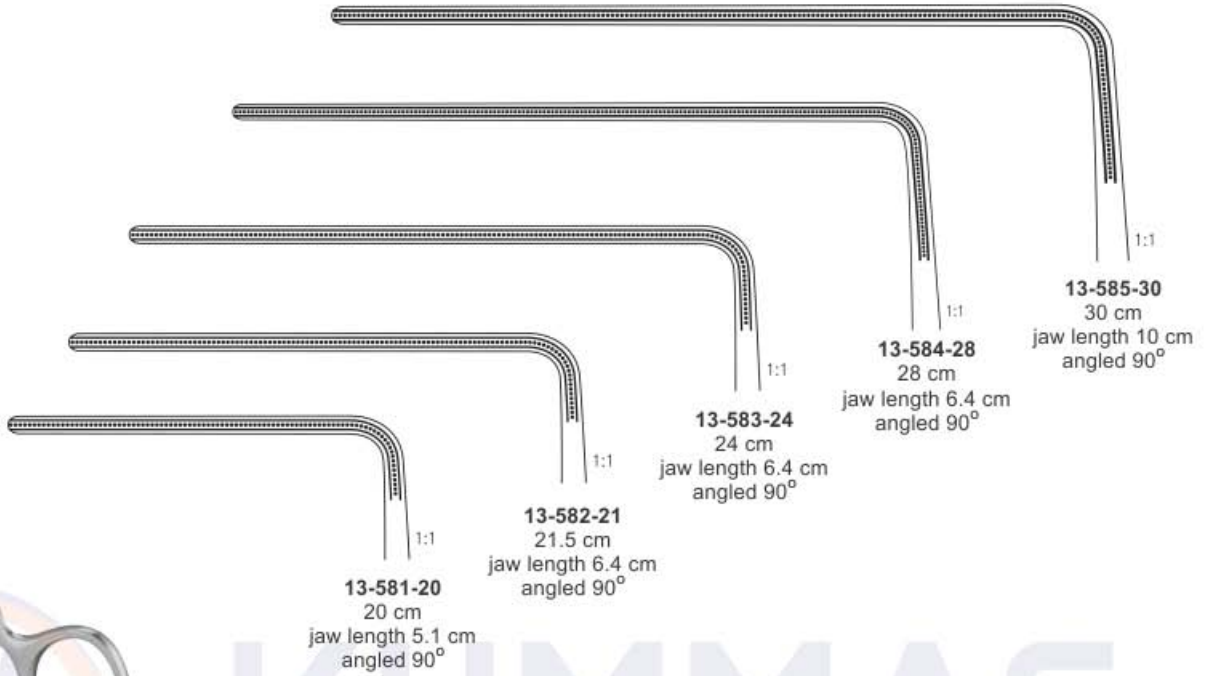

**KUMMAS**  
CORPORATION





**De Bakey Bahnson Clamp  
& Atraumatic Vascular Forceps**



**13-591-23**  
23 cm  
jaw length 5.5cm  
acute curve

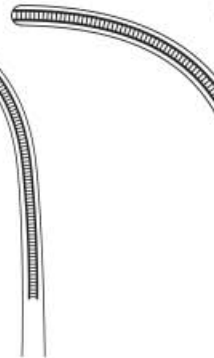

**13-592-27**  
27 cm  
jaw length 6cm  
acute curve

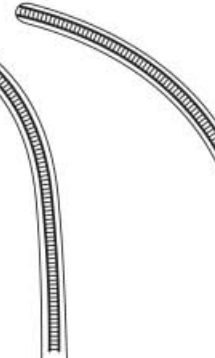

**13-593-29**  
29 cm  
jaw length 6.4 cm  
medium curve

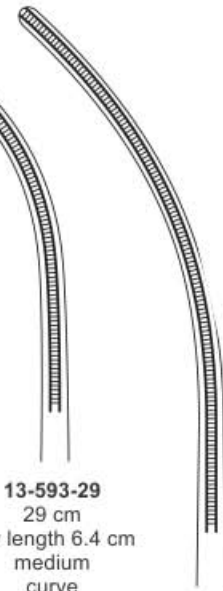

**13-594-27**  
27.5 cm  
jaw length 7.6 cm  
light curve



**Cooley & Atraumatic  
Cardiovascular Forceps**



**13-595-26**  
26.5 cm 1:1

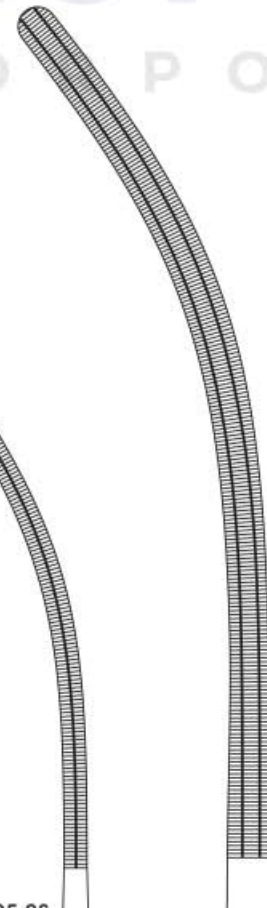

**13-596-33**  
33.5 cm

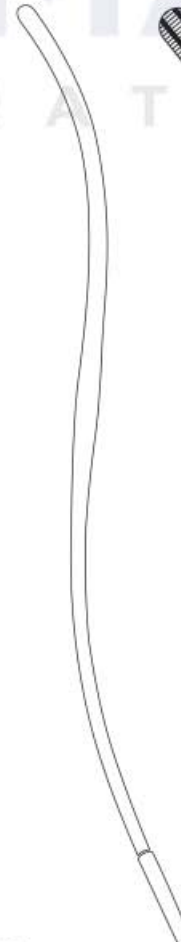

**13-597-31**  
31.5 cm  
S-curved



## MULTI-PURPOSE CLAMPS, VASCULAR FORCEPS

Mehrzweckklemmen, Gefäßzangen

Pinzas multiusos, pinzas vasculares

Pinces multi-usages, pinces vasculaires

Morsetti multiuso, pinze vascolari



**Leland-Jones, Atraumatic Vascular Forceps**

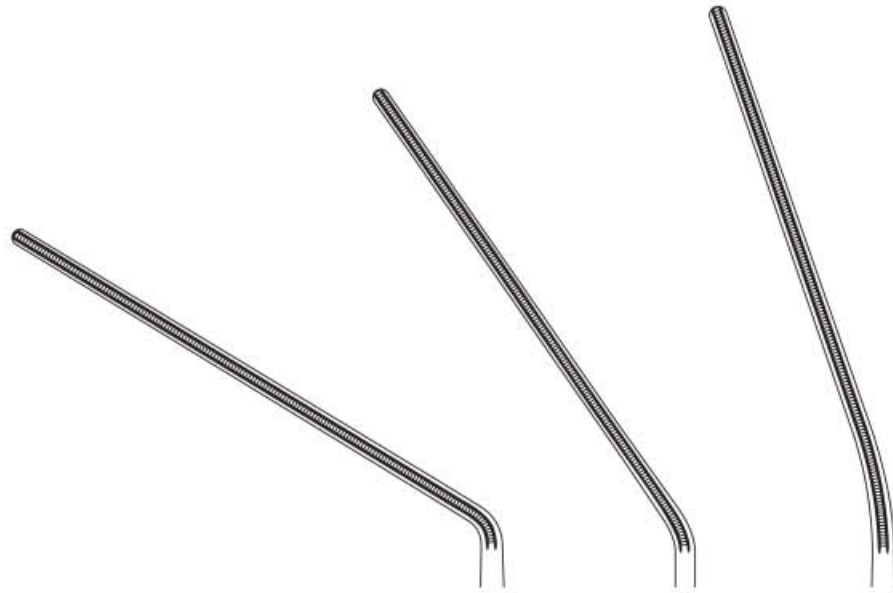

**13-598-45**  
18 cm  
jaw length  
7 cm  
angled 45°

**13-599-30**  
18 cm  
jaw length  
7 cm  
angled 30°

**13-400-15**  
18 cm  
jaw length  
7 cm  
angled 15°

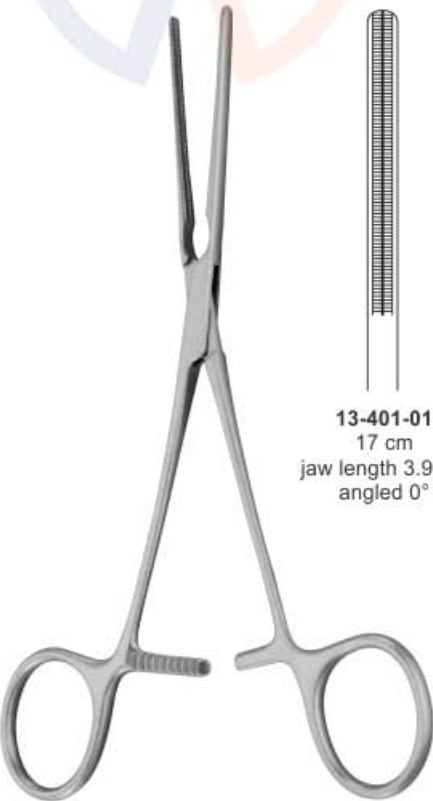

**Dardik Multipurpose Clamp & Atraumatic Vascular Forceps**

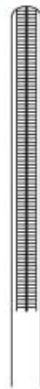

**13-401-01**  
17 cm  
jaw length 3.9 cm  
angled 0°

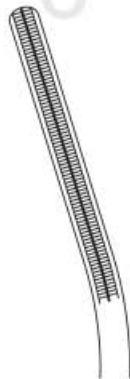

**13-402-15**  
17 cm  
jaw length 3.9 cm  
angled 15°



**13-403-30**  
17 cm  
jaw length 3.9 cm  
angled 30°

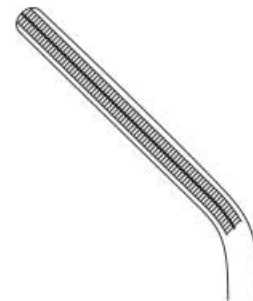

**13-404-45**  
17 cm  
jaw length 3.9 cm  
angled 45°

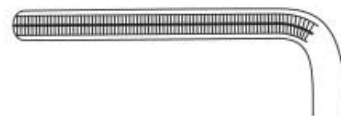

**13-405-90**  
17 cm  
jaw length 3.9 cm  
angled 90°



## AORTA CLAMP & VASCULAR FORCEPS

Aortenklamme & Gefäßzange

Pinza de aorta y pinzas vasculares

Pince aortique et pince vasculaire

Morsetto aortico e pinza vascolare

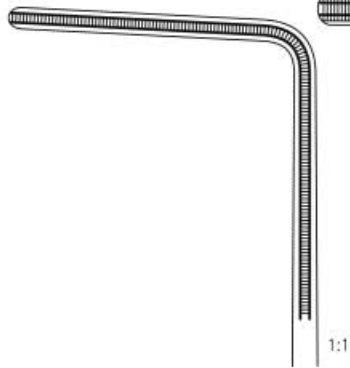

**13-406-23**  
23 cm  
jaw length 4 cm  
beyond angle

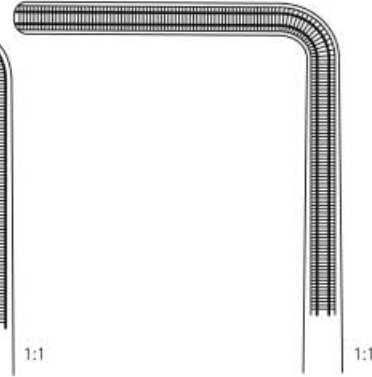

**13-407-25**  
25 cm  
jaw length 4 cm  
beyond angle

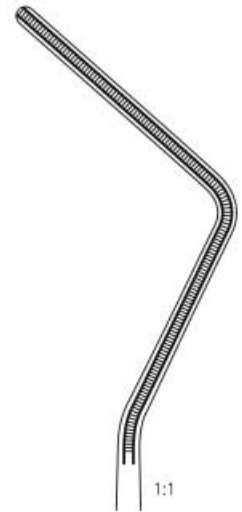

**13-408-25**  
25 cm  
jaw length 4 cm  
beyond angle

### Lees Right Angle Clamps & Atraumatic Vascular Forceps

KUMMAS  
CORPORATION



**Morris-De Bakey Aorta Clamp & Atraumatic Vascular Forceps**

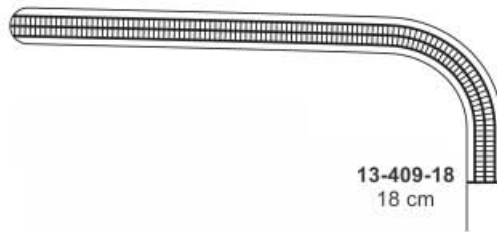

**13-409-18**  
18 cm

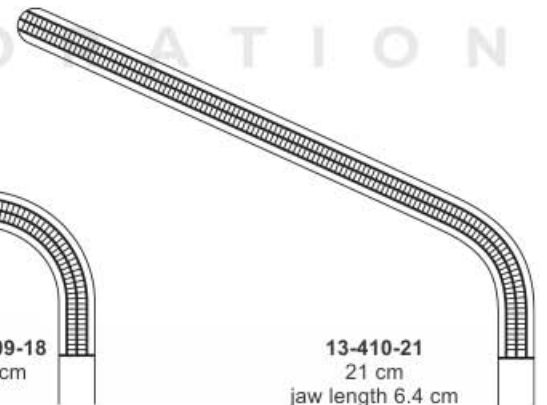

**13-410-21**  
21 cm  
jaw length 6.4 cm

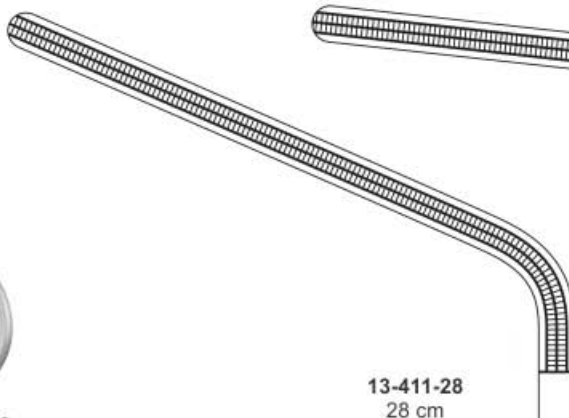

**13-411-28**  
28 cm  
jaw length 7cm

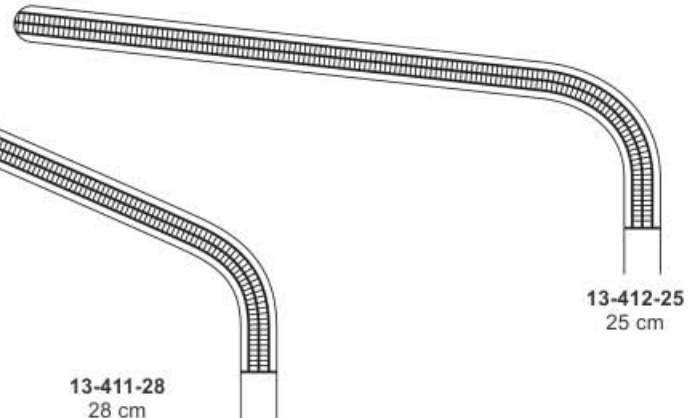

**13-412-25**  
25 cm



**Cooley Peripheral Vascular Clamp**  
**13-413-16** 16.5 cm  
 jaw length 3.5 cm  
 straight jaw



**Cooley Peripheral Vascular Clamp**  
 16.5 cm light jaw angled 55°  
**13-414-01** jaw length 3.5 cm  
**13-415-02** jaw length 4.4 cm



**Cooley Peripheral Vascular Clamp**  
 17.8 cm light jaw angled 55°  
**13-416-01** jaw length 7 cm  
**13-417-02** jaw length 4.4 cm



**Cooley Peripheral Vascular Clamp**  
**13-418-16** 16 cm  
 jaw length 3cm, curved jaw



**Debakey Peripheral Vascular Clamp**  
**13-419-17** 17.8 cm  
 jaw length 6 cm  
 slight curve in shank and angled jaw



**Debakey Peripheral Vascular Clamp**  
**13-420-15** 15 cm  
 jaw length 4.8 cm  
 curved jaw

## PERIPHERAL VASCULAR CLAMPS, AORTA CLAMP

Periphere Gefäßklemmen, Aortenklamme

Pinzas vasculares periféricas, pinza de aorta

Clamps Vasculaires Périphériques, Clamp Aorte

Morsetti vascolari periferici, morsetto aortico



**Debaquey Peripheral Vascular Clamp**  
**13-421-20** 20 cm  
 jaw length 8.5cm  
 S- shape

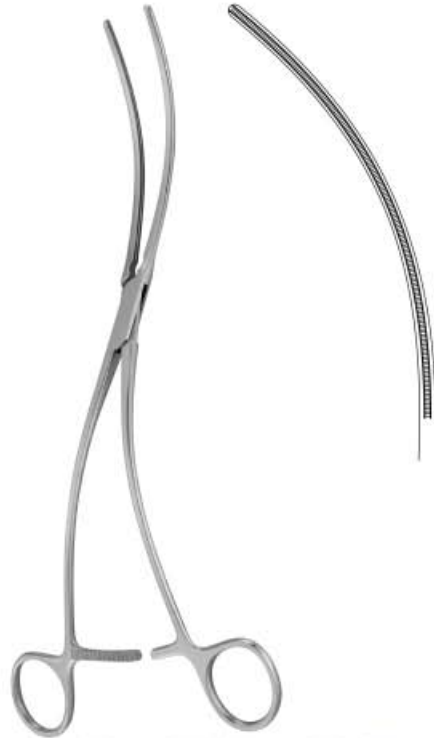

**Debaquey Peripheral Vascular Clamp & Forceps**  
**13-422-30** 30 cm  
 jaw length 8cm S-Curved



**Selman Peripheral Blood Vessel Forceps**

**13-423-01** 12.7 cm jaw length 1.3 cm  
 straight cooley jaws  
**13-424-02** 14 cm jaw length 2.3 cm  
 straight cooley jaws  
**13-425-01** 12.7 cm jaw length 1.3 cm  
 angled cooley jaws  
**13-426-02** 14 cm jaw length 2.3 cm  
 angled cooley jaws



**Zanger Abdominal Aorta Clamp**  
**13-427-22** 22 cm jaw length 6.5 cm  
**13-428-25** 25 cm jaw length 8.5 cm  
**13-429-30** 30 cm jaw length 10.5 cm



**Wylie abdominal Aorta Clamp**  
**13-430-26** 26.5 cm  
 jaw length 4 cm



**De Bakey - Semb Atraumatic Vascular Forceps**

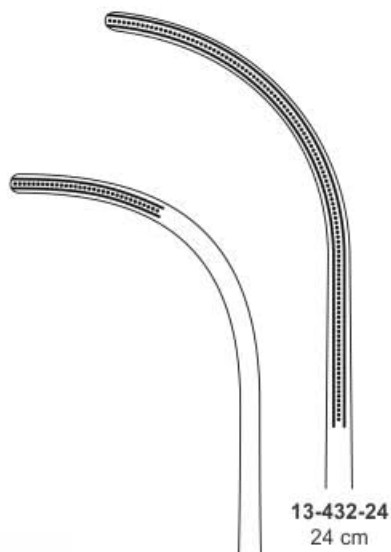

13-431-24  
24 cm



**De Bakey Semb Ligature Carrier Atraumatic Vascular Forceps**

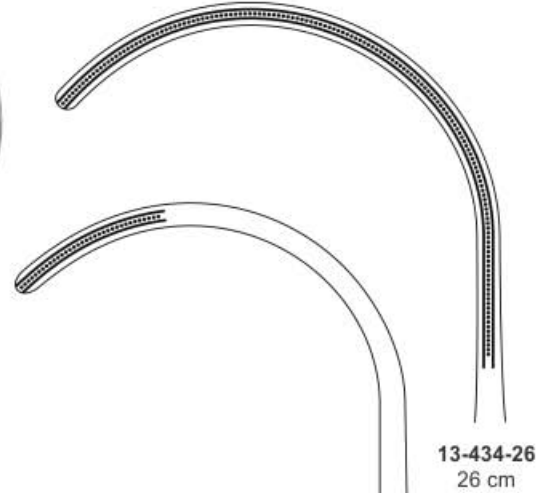

13-433-25  
25 cm  
jaw length 5.7 cm  
length of serrations 1.5 cm



**Harken Auricle Clamp**  
24 cm Curved

13-435-01  
Fig. 1

13-436-02  
Fig. 2

13-437-03  
Fig. 3

13-438-04  
Fig. 4

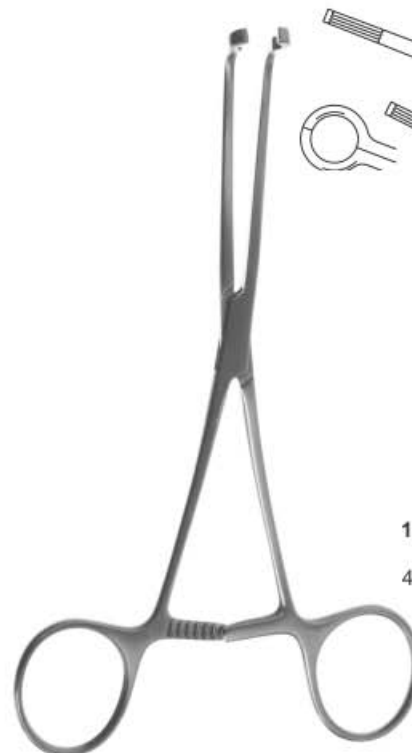

**Javid Carotid Artery Bypass Clamps & Atraumatic Vascular Forceps**

13-439-16  
16 cm  
4 mm ring

13-440-18  
18 cm  
6 mm ring





**Dale Femoral-Popliteal Clamps  
& Atraumatic Vascular Forceps**

**13-441-13**  
18 cm  
depth 1.3 cm  
small

**13-442-19**  
18 cm  
depth 1.9 cm  
medium

**13-443-25**  
18 cm  
depth 2.5 cm  
large

**Wylie "J" Clamp &  
Atraumatic Vascular Forceps**  
**13-444-21** 21 cm  
curved shanks,  
jaw length 4.5 cm  
depth 3.5 cm

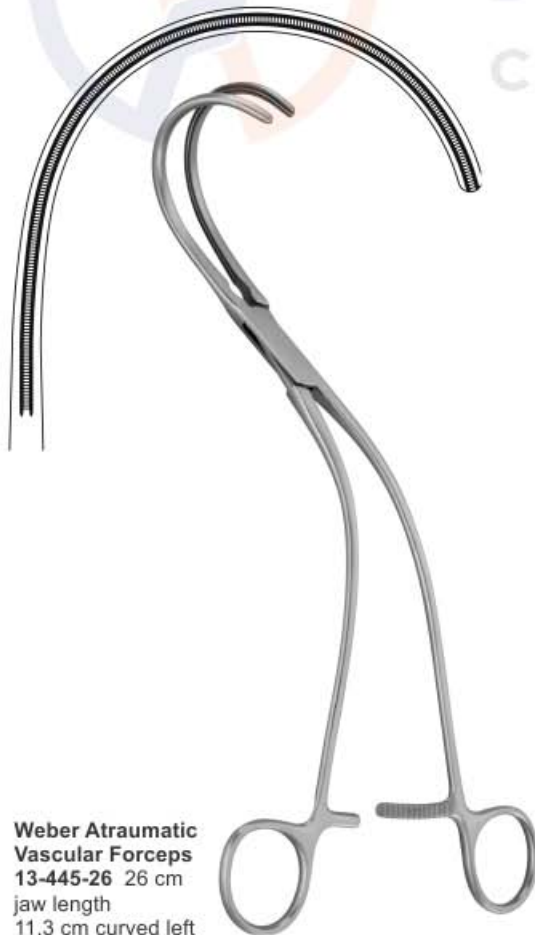

**Weber Atraumatic  
Vascular Forceps**  
**13-445-26** 26 cm  
jaw length  
11.3 cm curved left



**Weber Atraumatic  
Vascular Forceps**  
**13-446-26** 26 cm  
jaw length  
11.3 cm curved right

**KUMMAS**  
CORPORATION



**Hopkins Aorta clamp**  
**13-447-27** 27 cm  
 jaw length 7 cm  
 cooley jaws angled 45°  
 to the side



**Glover Spoon Shaped Clamp**  
 jaw length 4 cm, standard  
**13-448-21** 21.5 cm  
**13-449-24** 24 cm



**Glover Auricular Appendage Clamp**  
**13-450-23** 23 cm  
 jaw length 4.7 cm, depth 7mm

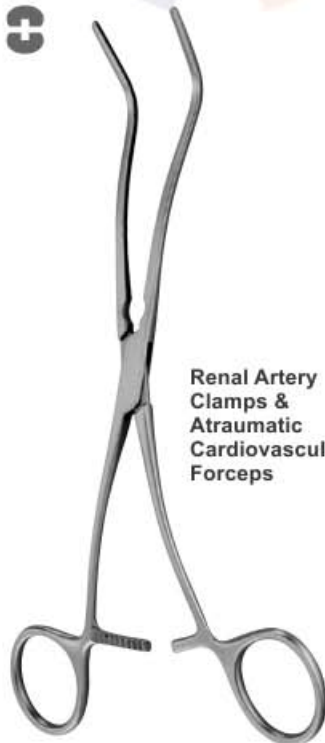

**Renal Artery  
 Clamps &  
 Atraumatic  
 Cardiovascular  
 Forceps**



**13-451-19**  
 19 cm  
 jaw length 6.5 cm



**13-452-02**  
 18.4cm  
 jaw length 5.8 cm

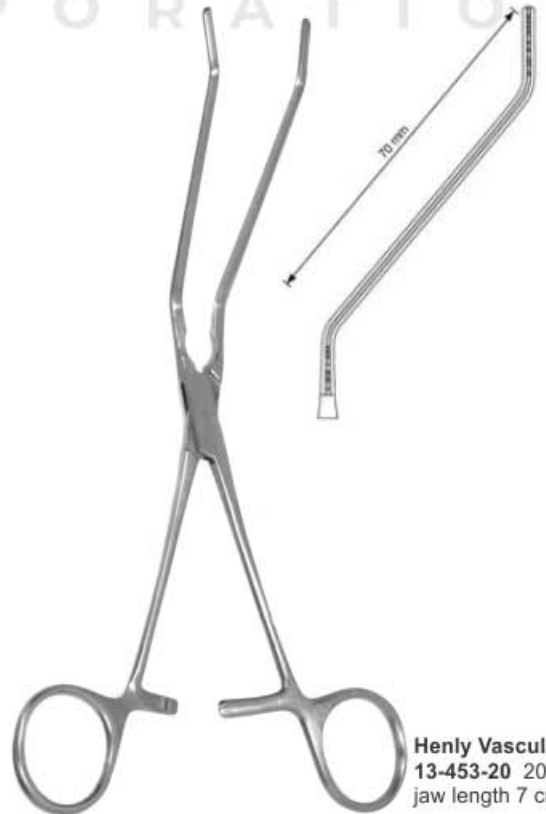

**Henly Vascular Clamp**  
**13-453-20** 20 cm  
 jaw length 7 cm



**Cooley-Baumgarten  
Aortic Clamp**  
13-454-19 19 cm  
jaw length 6.4 cm  
slightly curved jaw  
and shank



**Cooley Aortic Aneurysm Clamps**  
13-455-01 27 cm  
jaw length 7.6 cm  
slightly curved jaws  
13-456-02 25.5 cm  
jaw length 7.3 cm  
depth 1.9 cm  
curved shanks  
13-457-03 27 cm  
jaw length 5.4 cm  
depth 1.3 cm curved shanks  
13-458-04 20 cm  
jaw length 4.7 cm  
depth 1.3 cm curved shanks



**Fitzgerald Aortic Aneurysm Clamps**  
13-459-01 25 cm  
jaw length 7.5 cm  
slightly curved cooley jaws  
13-460-02 25 cm  
jaw length 8.5 cm  
slightly curved cooley jaws  
13-461-03 30.5 cm  
jaw length 10 cm  
slightly curved cooley jaws  
13-462-04 31 cm  
jaw length 12 cm  
slightly curved cooley jaws



**Howard DeBakey Aortic  
Aneurysm Clamp**  
13-463-31 31.5 cm  
jaw length 10 cm

## AORTA CLAMP & VASCULAR FORCEPS

Aortenklemme & Gefäßzange

Pinza de aorta y pinzas vasculares

Pince aortique et pince vasculaire

Morsetto aortico e pinza vascolare

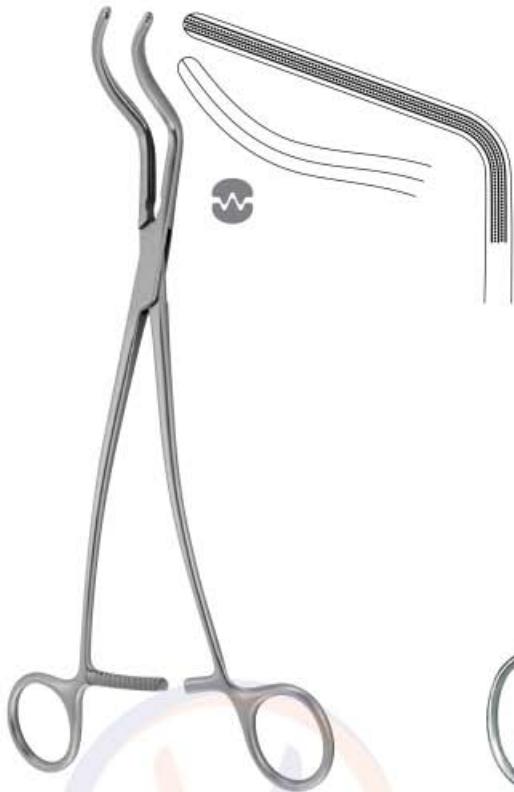

**De Bakey "sidewinder" Aorta Clamp & Atraumatic Vascular Forceps**  
**13-464-27** 27 cm  
 jaw length 6 cm  
 Double curved



**Subramanian-Miniature**  
**13-465-15**  
 Aortic Clamp 135 degree  
 15.5 cm



**Subramanian**  
**13-466-16**  
 Aortic Clamp  
 16 cm



**Subramanian "sidewinder" Aorta clamp**  
**13-467-14** 14 cm  
**13-468-16** 16 cm  
 jaw length 2.9 cm  
 double curved jaw

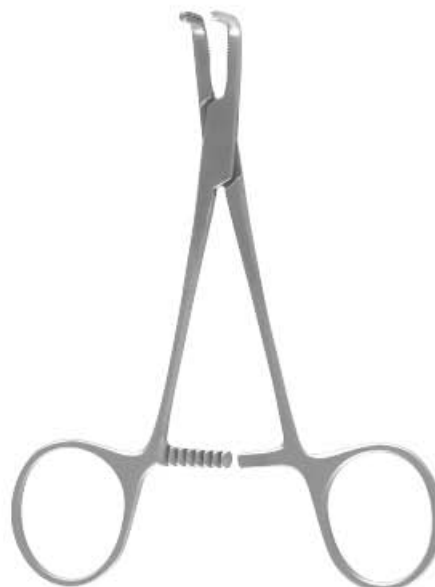

**Cooley Right Angle Clamps**  
 11.5 cm  
**13-469-17** jaw length 17mm  
**13-470-25** jaw length 25mm  
**13-471-35** jaw length 35mm















**Cooley Vena Cava Catheter Clamp**  
**13-472-24** 18.7cm 24-fr Child Size  
**13-473-26** 18.7cm 26-fr Child Size  
**13-474-28** 20.3cm 28-fr Adult Size  
**13-475-30** 20.3cm 30-fr Adult Size  
**13-476-32** 20.3cm 32-fr Adult Size  
**13-477-34** 20.3cm 34-fr Adult Size  
**13-478-36** 20.3cm 36-fr Adult Size













**De Bakey Vascular Dilator**  
malleable

 1:1	 1:1	 1:1	 1:1	 1:1	 1:1
0.5 mm Ø 13-479-01 19 cm 13-480-01 35 cm	1.0 mm Ø 13-481-02 19 cm 13-482-02 35 cm	1.5 mm Ø 13-483-03 19 cm 13-484-03 35 cm	2.0 mm Ø 13-485-04 19 cm 13-486-04 35 cm	2.5 mm Ø 13-487-05 19 cm 13-488-05 35 cm	3.0 mm Ø 13-489-06 19 cm 13-490-06 35 cm
 1:1	 1:1	 1:1	 1:1	 1:1	 1:1
3.5 mm Ø 13-491-07 19 cm 13-492-07 35 cm	4.0 mm Ø 13-493-08 19 cm 13-494-08 35 cm	4.5 mm Ø 13-495-09 19 cm 13-496-09 35 cm	5.0 mm Ø 13-497-10 19 cm 13-498-10 35 cm	7.0 mm Ø 13-499-11 19 cm 13-500-11 35 cm	9.0 mm Ø 13-501-12 19 cm 13-502-12 35 cm

C O R P O R A T I O N



**Cooley Vascular Dilator**  
13cm  
malleable

 1:1	 1:1	 1:1	 1:1
0.5 mm Ø 13-503-05	1.0 mm Ø 13-504-10	1.5 mm Ø 13-505-15	2.0 mm Ø 13-506-20
 1:1	 1:1	 1:1	 1:1
2.5 mm Ø 13-507-25	3.0 mm Ø 13-508-30	4.0 mm Ø 13-509-40	5.0 mm Ø 13-510-50





**Bailey-Gibbon  
Rib Contractors**  
13-527-20  
20 cm  
For Adult



**Bailey-Gibbon  
Rib Contractors**  
13-528-20  
20 cm  
For children



**Bailey-Baby  
Rib Contractors**  
13-529-15  
15 cm



**Sellers Rib Contractor**  
13-530-20 20 cm



**LEMMON**  
13-531-18  
18cm



**Blalock  
Rib Contractors**



13-532-01  
15 cm

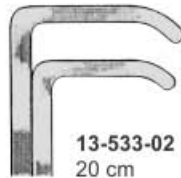

13-533-02  
20 cm

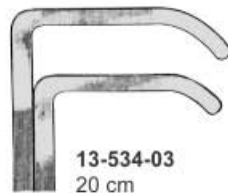

13-534-03  
20 cm

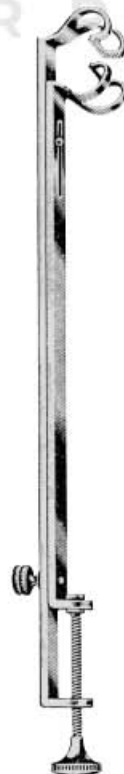

**Johns-Hopkins  
(Potts Modif.)  
Rib Contractors**



13-535-01  
20 cm



13-536-02  
20 cm



13-537-03  
20 cm

# RIB RASPATORIES

Rippen-Raspatorien

Raspadores de costillas

Râpes à côtes

Rasatori costali

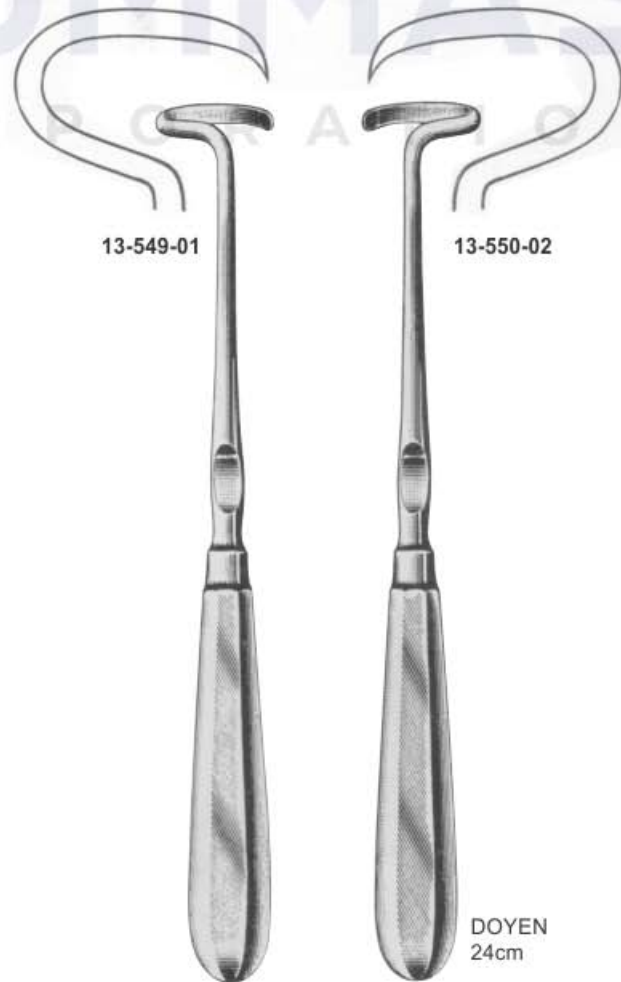



## RIB RASPATORIES

Rippen-Raspatorien  
Râpes à côtes

Raspadores de costillas  
Rasatori costali

17mm



8mm

**Davidson-Alexander**  
Rib raspatory,  
double-ended,  
13-551-29  
29cm



**Overholt**  
13-552-01  
# 1, 31cm



**Overholt**  
13-553-02  
# 2, 29cm



**Overholt**  
13-554-03  
# 3, 29cm

11mm



**Robert-Nelson**  
13-556-21 21cm  
11mm wide

15mm



**Matson**  
13-557-22  
22cm  
double-ended

10mm

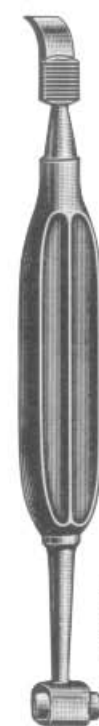

**Alexander-Farabeuf**  
13-558-22  
22cm  
double-ended

12mm



**Nelson**  
13-555-15  
15cm  
angle-bent,  
12mm wide

Lungenspatel, Aorta-Dilatatoren

Spatules pulmonaires, Dilatateurs pour aorte

Espátulas pulmonares, Dilatadores aórticos

Spatole per pulmone, Dilatatori per aorta



**Allison Lung Spatula Retractor**  
 13-559-25 25cm, 38mm wide  
 13-560-30 30cm, 40mm wide  
 13-561-32 32cm, 54mm wide

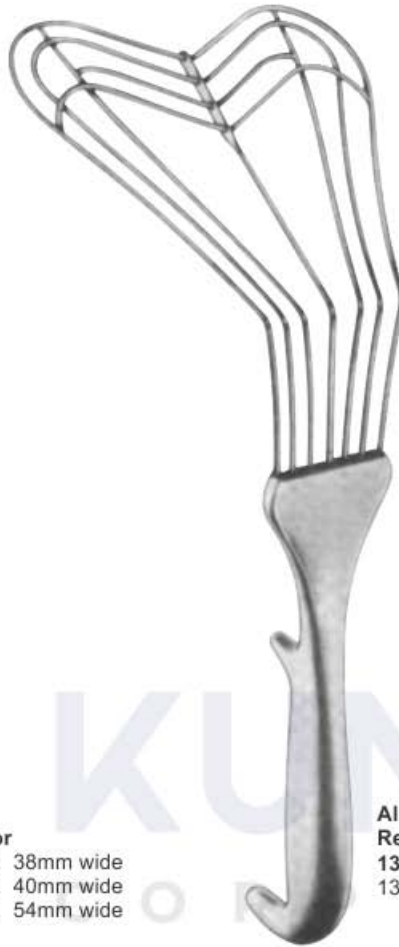

**Allison Lung Spatula Retractor**  
 13-562-30 32.4 cm  
 132mm wide



**Semb Lung Retractor**  
 13-563-20 # 1  
 13-564-24 # 2  
 25cm

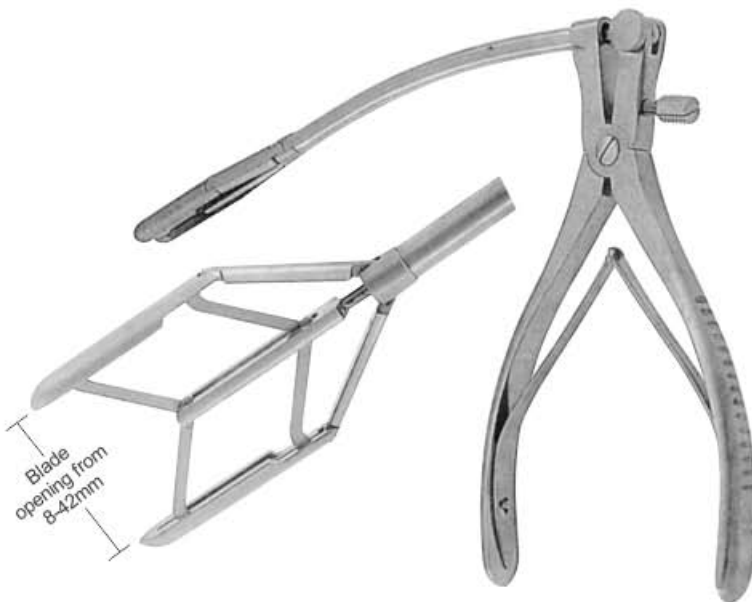

Blade opening from 8-42mm

**Tubbs Mitral Valve Aortic Dilator**  
 13-565-00  
 Blade Opening  
 From 8 To 42 mm



6-15mm

**Cooley Blade Aortic Dilator**  
 13-566-00  
 Blade Opening  
 From 8 To 15 mm

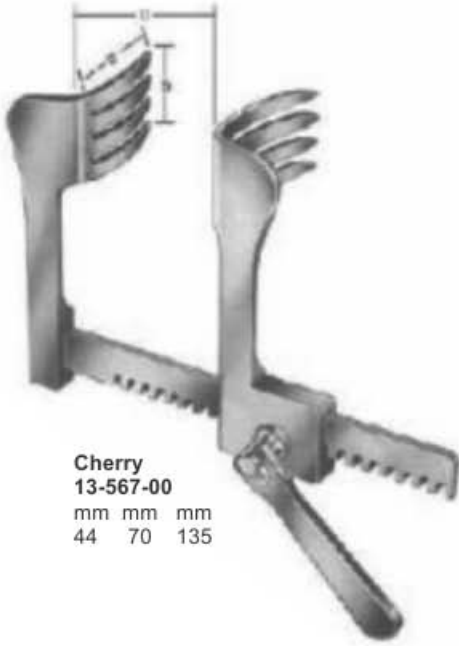

**Cherry**  
**13-567-00**  
mm mm mm  
44 70 135



**13-569-01**  
48 x 68 mm  
pair



**13-570-02**  
70 x 75 mm  
pair

De BAKEY  
**13-571-00**  
with 3 pairs of blades  
**13-573-11 to 13-575-13**  
Components for **13-571-00**  
**13-572-01** Spreader only  
Pair Blades only

**13-573-11** 30x30mm  
**13-574-12** 40x40mm  
**13-575-13** 50x50mm  
The blades are delivered in pairs.

**Thoracic Rib Retractors**

**13-568-00** Retractor only  
**13-569-01** pair of blades, 48 x 68 mm  
**13-570-02** 1 pair of blades, 70 x 75 mm

**KUMMAS**  
CORPORATION

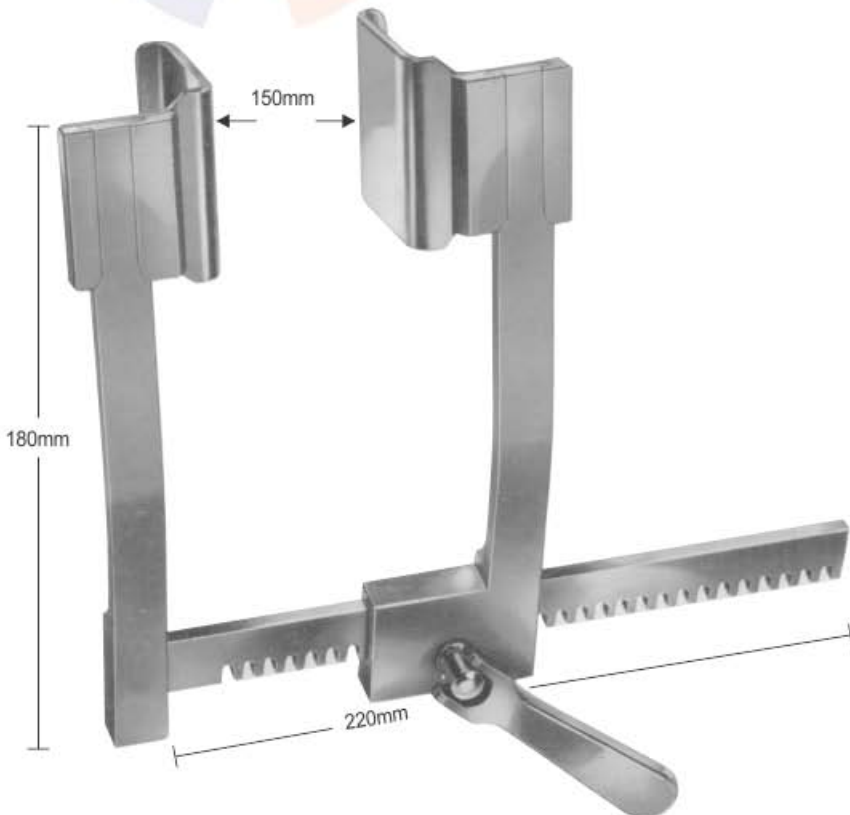

**13-573-11**  
Blades  
30x30mm



**13-574-12**  
Blades  
40x40mm



**13-575-13**  
Blades  
50x50mm



De BAKEY  
**49-570-00**  
 with 3 pairs of blades **49-570-11 - 49-570-15**  
 Components for **49-570-00**  
**49-570-01** Spreader only  
 pairs Blades only  
**49-570-11** 60x60mm  
**49-570-12** 50x80mm  
**49-570-13** 40x100mm

**49-570-11**  
Blades  
60x60mm



**49-570-12**  
Blades  
50x80mm



**49-570-13**  
Blades  
40x100mm



**49-570-14**  
Blades  
80x60mm



**49-570-15**  
Sternotomy  
Blades  
50x66mm

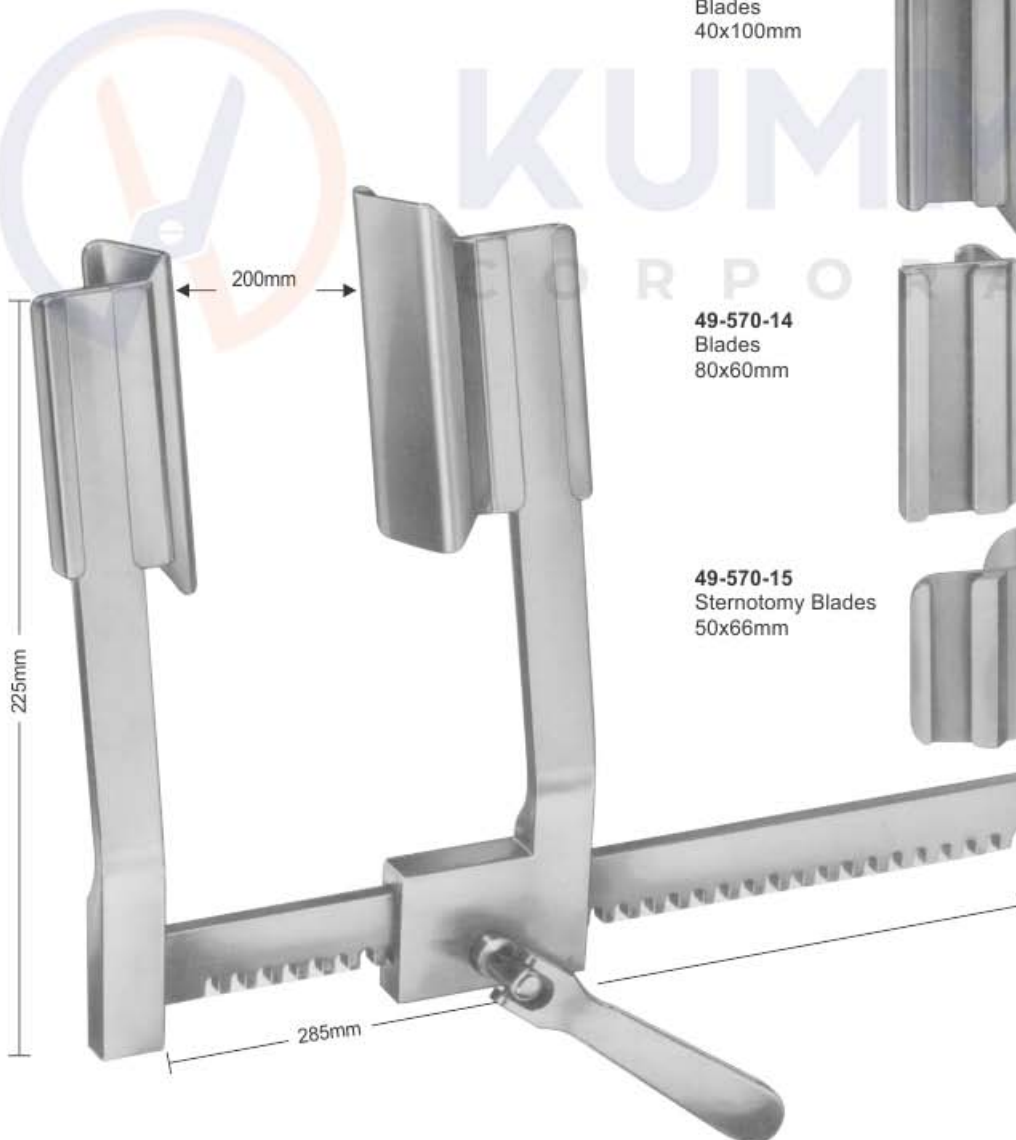



## RIB RETRACTORS

Rippensperrer | Ecarteur de côtes  
 Separador costal | Divaricatore costale



**Cooley Rib Retractors**  
**13-576-00**  
 lateral blades 12 x 16 mm spreading 95 mm



**Cooley Rib Retractors**  
**13-577-00** lateral blades 15 x 30 mm, spreading 140 mm  
**13-578-00** lateral blades 21 x 44 mm, spreading 150 mm



**Cooley Rib Retractors**  
**13-579-00**  
 lateral blades 35 x 50 mm, spreading 200 mm



**Finocchietto, Rib Retractors**

		lateral blades,	spreading
<b>13-580-00</b>	infant	15 x 15 mm	75 mm
<b>13-581-00</b>	baby	31 x 31 mm	100 mm
<b>13-582-00</b>	child	40 x 45 mm	135 mm
<b>13-583-00</b>	adult	52 x 62 mm	175 mm
<b>13-584-00</b>	adult	84 x 65 mm	175 mm

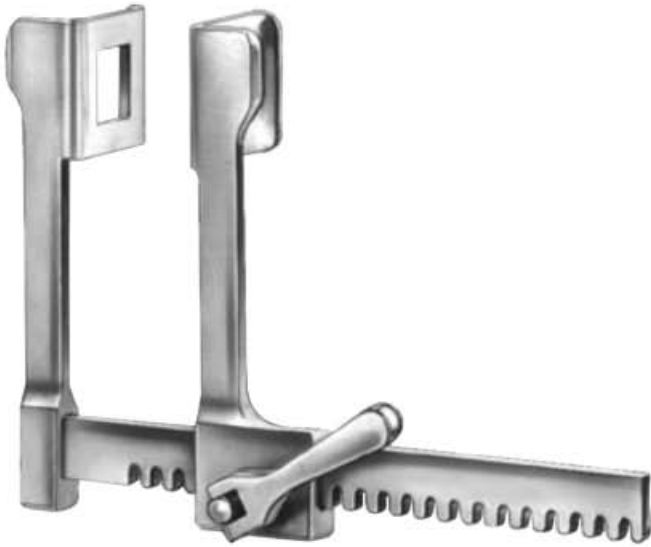

**Finocchietto/Baby Rib Retractors**  
13-585-00 7.5 cm  
14 mm x 15 mm spreading 75 mm



**Finocchietto, Rib Retractors**

- 13-586-00 30 mm x 45 mm spreading 150 mm
- 13-587-00 46 mm x 62 mm spreading 190 mm
- 13-588-00 80 mm x 65 mm spreading 190 mm



**Castaneda Rib Retractors**  
13-589-00 10.5 mm x 32 mm  
spreading 65 mm



**Castaneda Rib Retractors**  
13-590-00 12 mm x 45 mm  
spreading 70 mm



**Castaneda Rib Retractors**  
13-591-00 15 mm x 60 mm  
spreading 120 mm



**Haight Rib Retractor**  
13-592-00  
lateral blades 30 x 30 mm, spreading 120 mm



**Morse-Favaloro Sternal Retractor**  
13-593-00  
4 movable blades 17 x 22 mm, spreading 160mm for children

**KUMMAS**  
CORPORATION



**Morse**  
13-594-00  
Sternal Retractor 4 movable  
blades 22 x 27mm  
spreading 200 mm



**Finocchietto (Modif.) Rib Retractors**  
13-595-00  
lateral blades 14 x 15 mm, spreading 120 mm

## RIB RETRACTORS

Rippensperrer	Ecarteur de côtes
Separador costal	Divaricatore costale

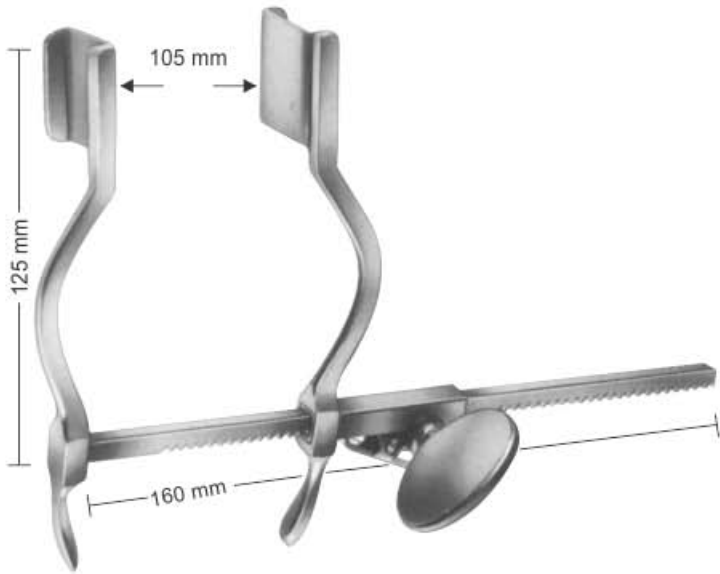

**Hertzler Rib Retractors**  
**13-596-00**  
 blades 20 x 25 mm, spreading 105 mm

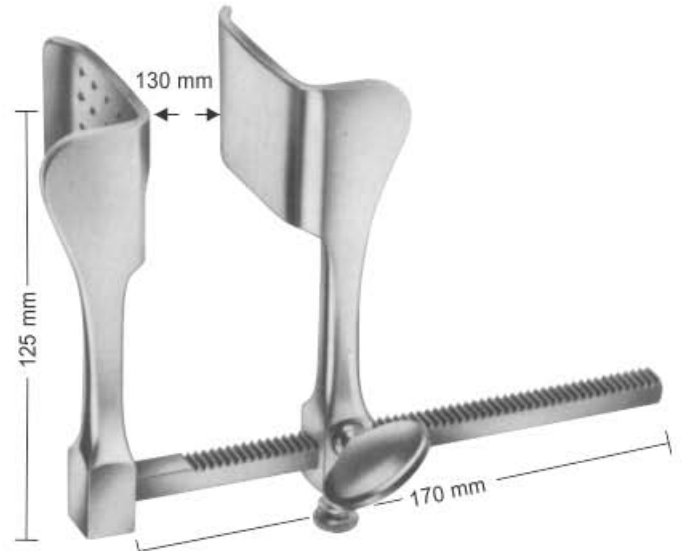

**Tuffier Rib Retractors**  
**13-597-00**  
 blades 43 x 53 mm, spreading 130 mm

KUMMAS  
CORPORATION



**Tuffier Rib Retractor**  
**13-598-00**  
 lateral blades 45 x 45 mm, spreading 160 mm  
**13-599-00**  
 lateral blades 22 x 27 mm, spreading 200 mm



**Thoracic & I.M.A Rib Retractors**  
**13-600-00** Complete set  
**13-601-01** lateral blades for I.M.A Retractor  
 left 40 x 50 x 80 mm  
**13-602-02** lateral blades for I.M.A Retractor  
 Right 40 x 50 x 80 mm



## RIB RETRACTORS

Rippensperrer

Ecarteur de côtes

Separador costal

Divaricatore costale



### Burford Rib Retractors

**13-603-00**

18 cm For children  
spread with 2 sets of Blades

**13-604-01** 48 mm x 42 mm spreading 135 mm

**13-605-02** 38 mm x 42 mm spreading 135 mm

KUMMAS CORPORATION



### Burford Rib Retractors

**13-606-00**

18 cm For Adults  
spread with 2 sets of Blades

**13-607-01** with two pair of blade 47 x 62 mm + 65 x 62 mm spreading 200 mm

**13-608-02** with 2 pair of blade 47 x 62 mm + 65 x 62 mm spreading 260 mm

**13-609-03** with 2 pair of blade 47 x 62 mm + 65 x 62 mm spreading 300 mm

## RIB RETRACTORS

Rippensperrer | Ecarteur de côtes  
 Separador costal | Divaricatore costale



Finocchietto - Infant

	a	b	c
13-610-00	15mm	15mm	75mm



Finocchietto - Baby  
child size

	a	b	c
13-611-00	31mm	31mm	100mm



Finocchietto

	a	b	c
13-612-01	38mm	44mm	135mm
13-613-02	52mm	62mm	135mm
13-614-03	85mm	65mm	135mm

## RIB RETRACTORS

Rippensperrer | Ecarteur de côtes  
 Separador costal | Divaricatore costale



Aluminium



Burford  
 for children  
 with 2 pairs of blades

	a	b	c
13-615-00	48mm	42mm	135mm



KUMMAS  
 CORPORATION

Aluminium



Burford  
 for adults  
 with 2 pairs of blades

	a	b	c
13-616-01	65mm	62mm	180mm
	47mm	62mm	
13-617-02	65mm	62mm	260mm
	47mm	62mm	
13-618-03	65mm	62mm	300mm
	47mm	62mm	

## RIB SHEARS, BONE HOLDING FORCEPS

Rippenschere, Knochenhaltezange | Tijeras para costillas, fórceps para sujetar huesos  
Cisailles à côtes, pinces à os | Cesoie per costole, pinza portaossa



**Semb Rib and Holding Forceps**  
13-619-20 20 cm



**Semb Rib and Holding Forceps with ratchet**  
13-620-20 20 cm



**Bone Rib Shear**  
13-621-19 19 cm  
13-622-23 23 cm



**Rib Shear**  
13-623-23 23 cm



**Gluck Rib Shear**  
13-624-22 22 cm

C O R P O R A T I O N



**Collin Rib Shears**  
13-625-19 19 cm



**Maurer-Collin Rib Shears**  
23 cm



**13-626-01**  
Hooked Left



**13-627-02**  
Hooked Right



**Bethune Rib Shear**  
13-628-34 34cm





**Doyen Rib Shears**  
13-629-19 19 cm



**Schuardt Rib Shears**  
13-630-17 17 cm



**Sauerbruch Rib Shears**  
13-631-24 24 cm, For Children  
13-632-27 27 cm, For Adults



**Lebsche  
Sternum Cutter**  
13-633-25  
25cm

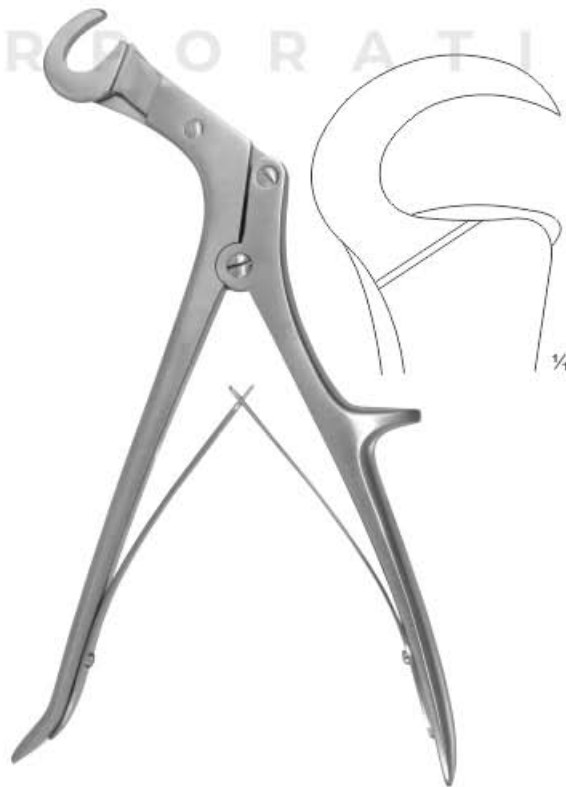

**Giertz-Stille Rib Shears**  
13-634-27  
27 cm



**Schumacher Rib Shears**  
sternum shears  
13-635-21 21 cm



**Sauerbruch-Frey Rib Shears**  
for the first rib  
13-636-37 37 cm

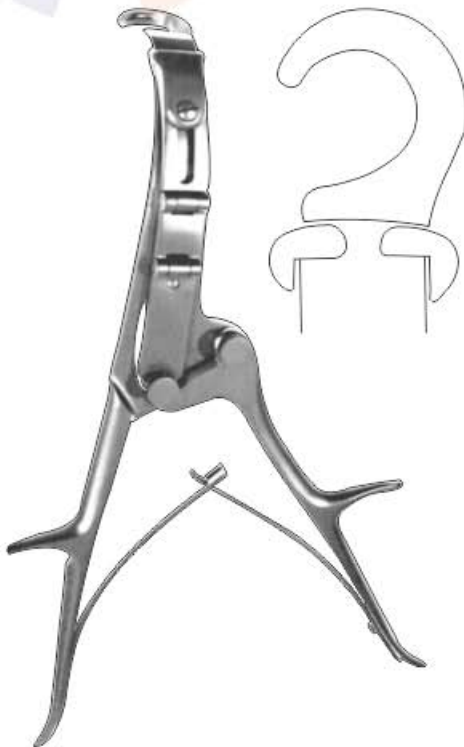

**Brunner Rib Shears**  
13-637-33  
33.5 cm



**Wolvek Sternal Crimper**  
13-638-01